

Chapter 3

Short Column Design

By Noel. J. Everard¹ and Mohsen A. Issa²

3.1 Introduction

The majority of reinforced concrete columns are subjected to primary stresses caused by flexure, axial force, and shear. Secondary stresses associated with deformations are usually very small in most columns used in practice. These columns are referred to as "short columns." Short columns are designed using the interaction diagrams presented in this chapter. The capacity of a short column is the same as the capacity of its section under primary stresses, irrespective of its length.

Long columns, columns with small cross-sectional dimensions, and columns with little end restraints may develop secondary stresses associated with column deformations, especially if they are not braced laterally. These columns are referred to as "slender columns". Fig. 3-1 illustrates secondary moments generated in a slender column by P- δ effect. Consequently, slender columns resist lower axial loads than short columns having the same cross-section. This is illustrated in Fig. 3-1. Failure of a slender column is initiated either by the material failure of a section, or instability of the column as a member, depending on the level of slenderness. The latter is known as column buckling. Design of slender columns is discussed in Chapter 4.

The classification of a column as a "short column" or a "slender column" is made on the basis of its "Slenderness Ratio," defined below.

Slenderness Ratio: $k\ell_u / r$

where, ℓ_u is unsupported column length; k is effective length factor reflecting end restraint and lateral bracing conditions of a column; and r is the radius of gyration reflecting the size and shape of a column cross-section. A detailed discussion of the parameters involved in establishing the slenderness ratio is presented in Chapter 4. Columns with slenderness ratios less than those specified in Secs. 10.12.2 and 10.13.2 for non-sway and sway frames, respectively, are designed as short columns using this chapter.

¹ Professor Emeritus of Civil Engineering, the University of Texas at Arlington, Arlington, Texas.

² Professor, Department of Civil and Materials Engineering, University of Illinois at Chicago, Illinois.

Non-sway frames are frames that are braced against sidesway by shear walls or other stiffening members. They are also referred to as “braced frames.” Sway frames are frames that are free to translate laterally so that secondary bending moments are induced due to P-δ effects. They are also referred to as “unbraced frames.” The following are the limiting slenderness ratios for short column behavior:

$$\text{Non-sway frames: } \frac{k\ell_u}{r} \leq 34 - 12(M_1/M_2) \quad (3.1)$$

$$\text{Sway frames: } \frac{k\ell_u}{r} \leq 22 \quad (3.2)$$

Where the term $[34 - 12(M_1/M_2)] \leq 40$ and the ratio M_1/M_2 is positive if the member is bent in single curvature and negative if bent in double curvature.

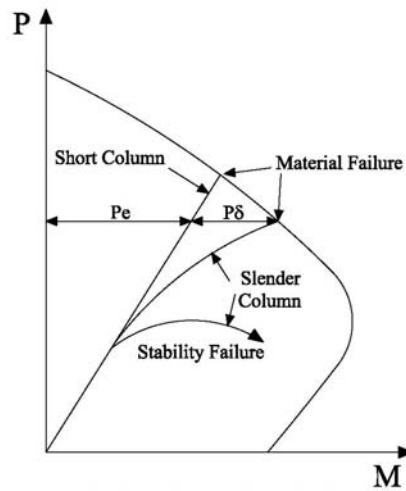

Fig. 3-1 Failure Modes in Short and Slender Columns

3.2 Column Sectional Capacity

In short columns the column capacity is directly obtained from column sectional capacity. The theory that has been presented in Section 1.2 of Chapter 1 for flexural sections, also applies to reinforced concrete column sections. However, column sections are subjected to flexure in combination with axial forces (axial compression and tension). Therefore, the equilibrium of internal forces changes, resulting in significantly different flexural capacities and behavioral modes depending on the level of accompanying axial load. Fig. 3-2 illustrates a typical column section subjected to combined bending and axial compression. As can be seen, different combinations of moment and accompanying axial force result in different column capacities and corresponding strain profiles, while also affecting the failure modes, i.e., tension or compression controlled behavior. The combination of bending moment and axial force that result in a column capacity is best presented by “column interaction diagrams.” Interaction diagrams are constructed by computing moment and axial force capacities, as shown below, for different strain profiles.

$$P_n = C_c + C_{s1} + C_{s2} - T_s \quad (3-3)$$

$$M_n = C_c x_2 + C_{s1} x_1 + T_s x_3 \quad (3-4)$$

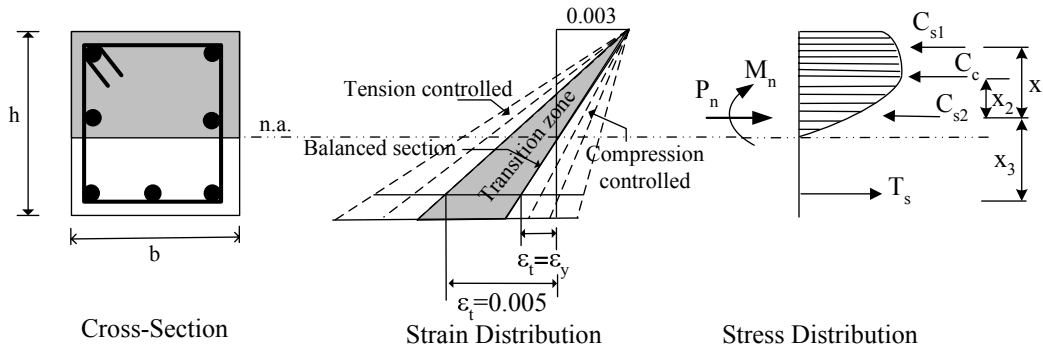

Fig. 3-2 Analysis of a column section

3.2.1 Column Interaction Diagrams

The column axial load - bending moment interaction diagrams included herein (**Columns 3.1.1** through **Columns 3.24.4**) conform fully to the provisions of ACI 318-05. The equations that were used to generate data for plotting the interaction diagrams were originally developed for ACI Special Publication SP-7³. In addition, complete derivations of the equations for square and circular columns having the steel arranged in a circle have been published in ACI Concrete International⁴. The original interaction diagrams that were contained in SP-7 were subsequently published in Special Publication SP-17A⁵.

The related equations were derived considering the reinforcing steel to be represented as follows:

- For rectangular and square columns having steel bars placed on the end faces only, the reinforcement was assumed to consist of two equal thin strips parallel to the compression face of the section.
- For rectangular and square columns having steel bars equally distributed along all four faces of the section, the reinforcement was considered to consist of a thin rectangular or square tube.
- For square and circular sections having steel bars arranged in a circle, the reinforcement was considered to consist of a thin circular tube.

The interaction diagrams were developed using the rectangular stress block, specified in ACI 318-05 (Sec. 10.2.7). In all cases, for reinforcement that exists within the compressed portion of the depth perpendicular to the compression face of the concrete ($a = \beta c$), the compression stress in the steel was reduced by $0.85 f'_c$ to account for the concrete area that is displaced by the reinforcing bars within the compression stress block.

The interaction diagrams were plotted in non-dimensional form. The vertical coordinate [$K_n = P_n / (f'_c A_g)$] represents the non-dimensional form of the nominal axial load capacity of the

³ Everard and Cohen. "Ultimate Strength Design of Reinforced Concrete Columns," ACI Special Publication SP-7, 1964, pp. 152-182.

⁴ Everard, N.J., "Axial Load-Moment Interaction for Cross-Sections Having Longitudinal Reinforcement Arranged in a Circle", ACI Structural Journal, Vol. 94, No. 6, November-December, 1997, pp. 695-699.

⁵ ACI Committee 340, "Ultimate Strength Design Handbook, Volume 2, Columns, ACI Special Publication 17-A, American Concrete Institute, Detroit, MI, 1970, 226 pages.

section. The horizontal coordinate $[R_n = M_n / (f'_c A_g h)]$ represents the non-dimensional nominal bending moment capacity of the section. The non-dimensional forms were used so that the interaction diagrams could be used equally well with any system of units (i.e. SI or inch-pound units). The strength reduction factor (ϕ) was considered to be 1.0 so that the nominal values contained in the interaction diagrams could be used with any set of ϕ factors, since ACI 318-05 contains different ϕ factors in Chapter 9, Chapter 20 and Appendix "C".

It is important to point out that the ϕ factors that are provided in Chapter 9 of ACI 318-05 are based on the strain values in the tension reinforcement farthest from the compression face of a member, or at the centroid of the tension reinforcement. Code Section 9.3.2 references Sections 10.3.3 and 10.3.4 where the strain values for tension control and compression control are defined.

It should be noted that the eccentricity ratios ($e/h = M/P$), sometimes included as diagonal lines on interaction diagrams, are not included in the interaction diagrams. Using that variable as a coordinate with either K_n or R_n could lead to inaccuracies because at the lower ends of the diagrams the e/h lines converge rapidly. However, straight lines for the tension steel stress ratios f_s / f_y have been plotted for assistance in designing splices in the reinforcement. Further, the ratio $f_s / f_y = 1.0$ represents steel strain $\varepsilon_y = f_y / E_s$, which is the boundary point for the ϕ factor for compression control, and the beginning of the transition zone for linear increase of the ϕ factor to that for tension control.

In order to provide a means of interpolation for the ϕ factor, other strain lines were plotted. The strain line for $\varepsilon_t = 0.005$, the beginning of the zone for tension control has been plotted on all diagrams. For steel yield strength 60.0 ksi, the intermediate strain line for $\varepsilon_t = 0.035$ has been plotted. For Steel yield strength 75.0 ksi, the intermediate strain line for $\varepsilon_t = 0.038$ has been plotted. It should be noted that all strains refer to those in the reinforcing bar or bars farthest from the compression face of the section. Discussions and tables related to the strength reduction factors are contained in two publications in Concrete International^{6,7}.

In order to point to designs that are prohibited by ACI 318-05, Section 10.3.5, strain lines for $\varepsilon_t = 0.004$ have also been plotted. Designs that fall within the confines of the lines for $\varepsilon_t = 0.004$ and K_n less than 0.10 are not permitted by ACI 318-05. This includes tension axial loads, with K_n negative. Tension axial loads are not included in the interaction diagrams. However, the interaction diagram lines for tension axial loads are very nearly linear from $K_n = 0.0$ to $R_n = 0.0$ with $[K_n = A_{st} f_y / (f'_c A_g)]$. This is discussed in the next section.

⁶ Everard, N. J., "Designing With ACI 318-02 Strength Reduction Factors", Concrete International, August, 2002, Vol. 24, No. 8, pp 91-93.

⁷ Everard, N. J., "Strain Related Strength Reduction Factors (ϕ) According to ACI 318-02, Concrete International, August, 2002, Vol. 34, No. 8, pp. 91-93.

Straight lines for K_{\max} are also provided on each interaction diagram. Here, K_{\max} refers to the maximum permissible nominal axial load on a column that is laterally reinforced with ties conforming to ACI 318-05 Section 7.10.5. Defining K_0 as the theoretical axial compression capacity of a member with $R_n = 0.0$, $K_{\max} = 0.80K_0$, or, considering ACI 318-05 Eq. (10-2), without the ϕ factor,

$$P_{n,\max} = 0.8 [0.85 f'_c (A_g - A_{st}) + f_y A_{st}] \quad (3-5)$$

Then,

$$K_{\max} = P_{\max} / f'_c A_g \quad (3-6)$$

For columns with spirals conforming with ACI 318-05 Section 7.10.4, values of K_{\max} from the interaction diagrams are to be multiplied by 0.85/0.80 ratio.

The number of longitudinal reinforcing bars that may be contained is not limited to the number shown in the illustrations on the interaction diagrams. They only illustrate the type of reinforcement patterns. However, for circular and square columns with steel arranged in a circle, and for rectangular or square columns with steel equally distributed along all four faces, it is a good practice to use at least 8 bars (and preferably at least 12 bars). Although side steel was assumed to be 50 percent of the total steel for columns having longitudinal steel equally distributed along all four faces, reasonably accurate and conservative designs result when the side steel consists of only 30 percent of the total steel. The maximum number of bars that may be used in any column cross section is limited by the maximum allowable steel ratio of 0.08, and the conditions of cover and spacing between bars.

3.2.2 Flexure with Tension Axial Load

Many studies concerning flexure with tension axial load show that the interaction diagram for tension axial load and flexure is very nearly linear between R_0 and the tension axial load value K_{nt} , as is shown in Fig. 3-3. Here, R_0 is the value of R_n for $K_n = 0.0$, and $K_{nt} = A_{st} f_y / (f'_c A_g)$

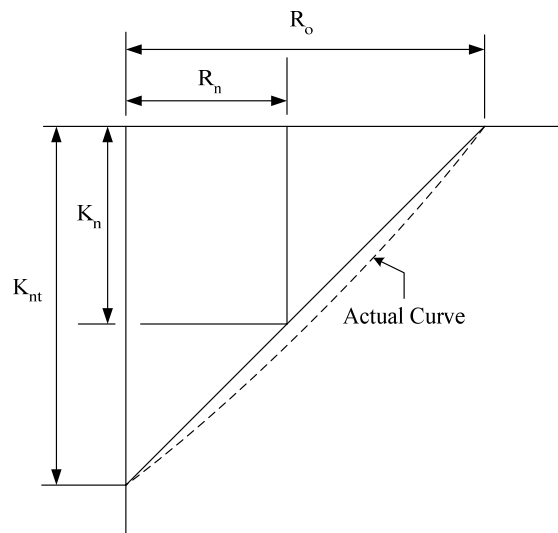

Fig. 3.3 Flexure with axial tension

Design values for flexure with tension axial load can be obtained using the equations:

$$K_n = K_m [1.0 - R_n/R_o] \quad (3-7)$$

$$R_n = R_o [1.0 - K_n/K_m] \quad (3-8)$$

Also, the tension side interaction diagram can be plotted as a straight line using R_o and K_m , as is shown in Fig. 3.3.

3.3 Columns Subjected to Biaxial Bending

Most columns are subjected to significant bending in one direction, while subjected to relatively small bending moments in the orthogonal direction. These columns are designed by using the interaction diagrams discussed in the preceding section for uniaxial bending and if required checked for the adequacy of capacity in the orthogonal direction. However, some columns, as in the case of corner columns, are subjected to equally significant bending moments in two orthogonal directions. These columns may have to be designed for biaxial bending.

A circular column subjected to moments about two axes may be designed as a uniaxial column acted upon by the resultant moment;

$$M_u = \sqrt{M_{ux}^2 + M_{uy}^2} \geq \phi M_n = \sqrt{M_{nx}^2 + M_{ny}^2} \quad (3-9)$$

For the design of rectangular columns subjected to moments about two axes, this handbook provides design aids for two methods: 1) The Reciprocal Load ($1/P_i$) Method suggested by Bresler⁸, and 2) The Load Contour Method developed by Parme, Nieves, and Gouwens⁹. The Reciprocal Load Method is more convenient for making an analysis of a trial section. The Load Contour Method is more suitable for selecting a column cross section. Both of these methods use the concept of a failure surface to reflect the interaction of three variables, the nominal axial load P_n and the nominal biaxial bending moments M_{nx} and M_{ny} , which in combination will cause failure strain at the extreme compression fiber. In other words, the failure surface reflects the strength of short compression members subject to biaxial bending and compression. The bending axes, eccentricities and biaxial moments are illustrated in Fig. 3.4.

⁸ Bresler, Boris. "Design Criteria for Reinforced Columns under Axial Load and Biaxial Bending," ACI Journal Proceedings, V. 57, No.11, Nov. 1960, pp. 481-490.

⁹ Parme, A.L. Nieves, J. M. and Gouwens, A. "Capacity of Reinforced Rectangular Columns Subjected to Biaxial Bending." ACI Journal Proceedings, V. 63, No. 9, Sept. 1966, pp.911-923.

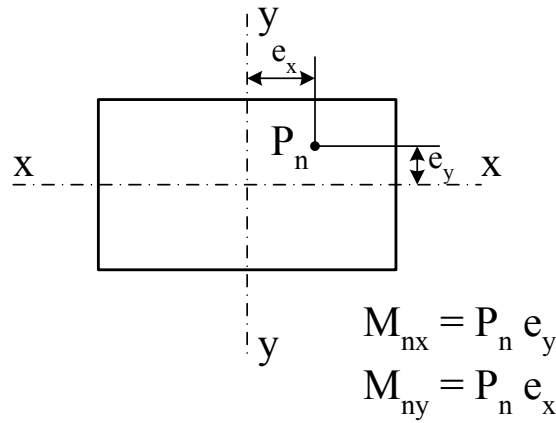

Fig. 3.4 Notations used for column sections subjected to biaxial bending

A failure surface S_1 may be represented by variables P_n , e_x , and e_y , as in Fig. 3.5, or it may be represented by surface S_2 represented by variables P_n , M_{nx} , and M_{ny} as shown in Fig. 3.6. Note that S_1 is a single curvature surface having no discontinuity at the balance point, whereas S_2 has such a discontinuity. (When biaxial bending exists together with a nominal axial force smaller than the lesser of P_b or $0.1 f_c A_g$, it is sufficiently accurate and conservative to ignore the axial force and design the section for bending only.)

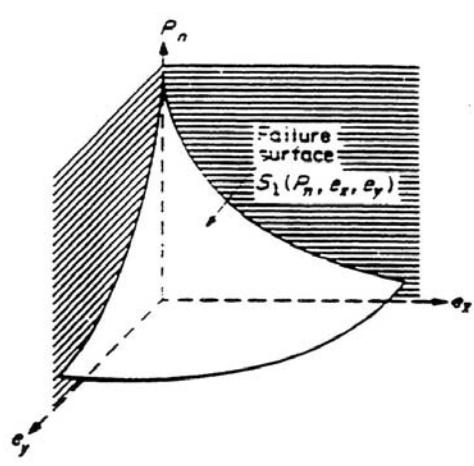

Fig. 3.5 Failure surface S_1

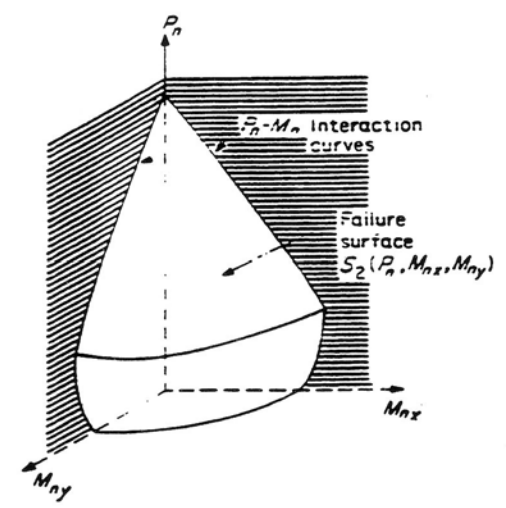

Fig. 3.6 Failure surface S_2

3.3.1 Reciprocal Load Method

In the reciprocal load method, the surface S_1 is inverted by plotting $1/P_n$ as the vertical axis, giving the surface S_3 , shown in Fig. 3.7. As Fig. 3.8 shows, a true point $(1/P_{ni}, e_{xA}, e_{yB})$ on this reciprocal failure surface may be approximated by a point $(1/P_{ni}, e_{xA}, e_{yB})$ on a plane S'_3 passing through Points A, B, and C. Each point on the true surface is approximated by a different plane; that is, the entire failure surface is defined by an infinite number of planes.

Point A represents the nominal axial load strength P_{ny} when the load has an eccentricity of e_{xA} with $e_y = 0$. Point B represents the nominal axial load strength P_{nx} when the load has an eccentricity of e_{yB} with $e_x = 0$. Point C is based on the axial capacity P_o with zero eccentricity. The equation of the plane passing through the three points is;

$$\frac{1}{P_{ni}} = \frac{1}{P_{nx}} + \frac{1}{P_{ny}} - \frac{1}{P_o} \quad (3-10)$$

Where:

- P_{ni} : approximation of nominal axial load strength at eccentricities e_x and e_y
- P_{nx} : nominal axial load strength for eccentricity e_y along the y-axis only (x-axis is axis of bending)
- P_{ny} : nominal axial load strength for eccentricity e_x along the x-axis only (y-axis is axis of bending)
- P_o : nominal axial load strength for zero eccentricity

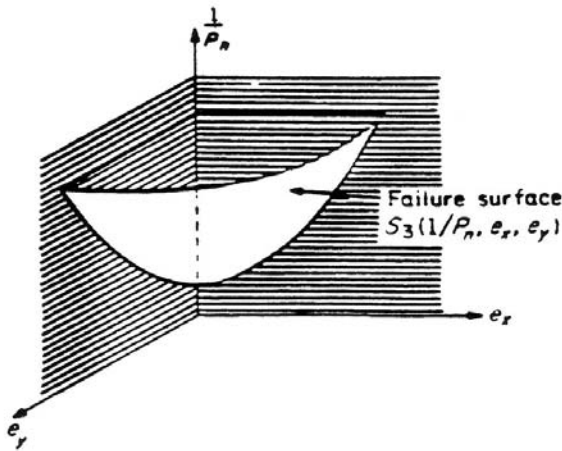

Fig. 3.7 Failure surface S_3 , which is reciprocal of surface S_1

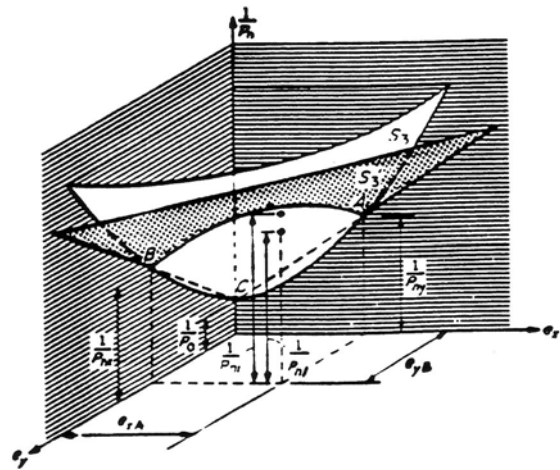

Fig. 3.8 Graphical representation of Reciprocal Load Method

For design purposes, when ϕ is constant, the $1/P_{ni}$ equation given in Eq. 3.9 may be used. The variable $K_n = P_n / (f'_c A_g)$ can be used directly in the reciprocal equation, as follows:

$$\frac{1}{K_{ni}} = \frac{1}{K_{nx}} + \frac{1}{K_{ny}} - \frac{1}{K_o} \quad (3-11)$$

Where, the values of K refer to the corresponding values of P_n as defined above. Once a preliminary cross section with an estimated steel ratio ρ_g has been selected, the actual values of R_{nx} and R_{ny} are calculated using the actual bending moments about the cross section X and Y axes, respectively. The corresponding values of K_{nx} and K_{ny} are obtained from the interaction diagrams presented in this Chapter as the intersection of appropriate R_n value and the assumed steel ratio curve for ρ_g . Then, the

value of the theoretical compression axial load capacity K_o is obtained at the intersection of the steel ratio curve and the vertical axis for zero R_n .

3.3.2 Load Contour Method

The load contour method uses the failure surface S_2 (Fig. 3.6) and works with a load contour defined by a plane at a constant value of P_n , as illustrated in Fig. 3.9. The load contour defining the relationship between M_{nx} and M_{ny} for a constant P_n may be expressed nondimensionally as follows:

$$\left(\frac{M_{nx}}{M_{nox}} \right)^\alpha + \left(\frac{M_{ny}}{M_{noy}} \right)^\alpha = 1 \quad (3-12)$$

For design, if each term is multiplied by ϕ , the equation will be unchanged. Thus M_{ux} , M_{uy} , M_{ox} , and M_{oy} , which should correspond to ϕM_{nx} , ϕM_{ny} , ϕM_{nox} , and ϕM_{noy} , respectively, may be used instead of the original expressions. This is done in the remainder of this section. To simplify the equation (for application), a point on the nondimensional diagram Fig. 3.10 is defined such that the biaxial moment capacities M_{nx} and M_{ny} at this point are in the same ratio as the uniaxial moment capacities M_{ox} and M_{oy} ; thus

$$\frac{M_{nx}}{M_{ny}} = \frac{M_{ox}}{M_{oy}} \quad (3-12)$$

$$\text{or; } M_{nx} = \beta M_{ox} \quad \text{and} \quad M_{ny} = \beta M_{oy} \quad (3-13)$$

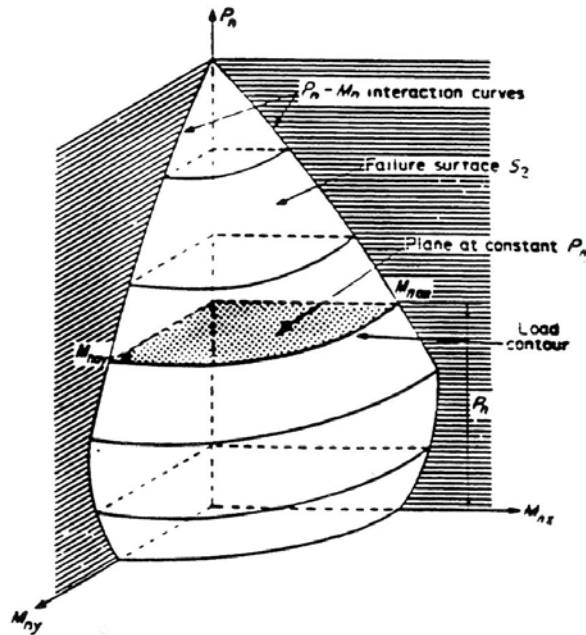

Fig. 3.10 Load contour for constant P_n on failure surface

In physical sense, the ratio β is the constant portion of the uniaxial moment capacities which may be permitted to act simultaneously on the column section. The actual value of β depends on the ratio P_n/P_{og} as well as properties of the material and cross section. However, the usual range is between 0.55 and 0.70. An average value of $\beta = 0.65$ is suggested for design. The actual values of β are available from **Columns 3.25**.

The load contour equation given above (Eq. 3-10) may be written in terms of β , as shown below:

$$\left(\frac{M_{nx}}{M_{nox}}\right)^{\log 0.5/\log \beta} + \left(\frac{M_{ny}}{M_{noy}}\right)^{\log 0.5/\log \beta} = 1 \quad (3-14)$$

A plot of the Eq. 3-12 appears as **Columns 3.26**. This design aid is used for analysis. Entering with M_{nx}/M_{ox} and the value of β from **Columns 3.25**, one can find permissible M_{ny}/M_{oy} . The relationship using β may be better visualized by examining Fig. 3.10. The true relationship between Points A, B, and C is a curve; however, it may be approximated by straight lines for design purposes. The load contour equations as straight line approximation are:

$$\text{i) For } \frac{M_{ny}}{M_{nx}} \geq \frac{M_{oy}}{M_{ox}} \quad M_{oy} = M_{ny} + M_{nx} \left(\frac{M_{oy}}{M_{ox}}\right) \left(\frac{1-\beta}{\beta}\right) \quad (3-13)$$

$$\text{ii) For } \frac{M_{ny}}{M_{nx}} \leq \frac{M_{oy}}{M_{ox}} \quad M_{ox} = M_{nx} + M_{ny} \left(\frac{M_{ox}}{M_{oy}}\right) \left(\frac{1-\beta}{\beta}\right) \quad (3-14)$$

For rectangular sections with reinforcement equally distributed on all four faces, the above equations can be approximated by;

$$M_{oy} = M_{ny} + M_{nx} \left(\frac{b}{h}\right) \left(\frac{1-\beta}{\beta}\right) \quad (3-15)$$

$$\text{For } \frac{M_{ny}}{M_{nx}} \leq \frac{M_{oy}}{M_{ox}} \quad \text{or} \quad \frac{M_{ny}}{M_{nx}} \leq \frac{b}{h}$$

where b and h are dimensions of the rectangular column section parallel to x and y axes, respectively. Using the straight line approximation equations, the design problem can be attacked by converting the nominal moments into equivalent uniaxial moment capacities M_{ox} or M_{oy} . This is accomplished by;

- (a) assuming a value for b/h
- (b) estimating the value of β as 0.65
- (c) calculating the approximate equivalent uniaxial bending moment using the appropriate one of the above two equations
- (d) choosing the trial section and reinforcement using the methods for uniaxial bending and axial load.

The section chosen should then be verified using either the load contour or the reciprocal load method.

3.4 Columns Examples

COLUMNS EXAMPLE 1 - Required area of steel for a rectangular tied column with bars on four faces (slenderness ratio found to be below critical value)

For a rectangular tied column with bars equally distributed along four faces, find area of steel.

Given: Loading

$P_u = 560$ kip and $M_u = 3920$ kip-in.
 Assume $\phi = 0.70$ or,
 Nominal axial load $P_n = 560/0.70 = 800$ kip
 Nominal moment $M_n = 3920/0.70 = 5600$ kip-in.

Materials

Compressive strength of concrete $f'_c = 4$ ksi
 Yield strength of reinforcement $f_y = 60$ ksi
 Nominal maximum size of aggregate is 1 in.

Design conditions

Short column braced against sidesway.

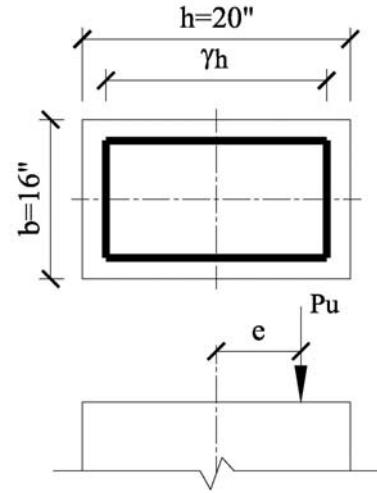

Procedure	Calculation	ACI 318-05 Section	Design Aid
Determine column section size.	Given: $h = 20$ in. $b = 16$ in.		
Determine reinforcement ration ρ_g using known values of variables on appropriate interaction diagram(s) and compute required cross section area A_{st} of longitudinal reinforcement.	$P_n = 800$ kip $M_n = 5600$ kip-in. $h = 20$ in. $b = 16$ in. $A_g = b \times h = 20 \times 16 = 320$ in. ²		
A) Compute $K_n = \frac{P_n}{f'_c A_g}$	$K_n = \frac{800}{(4)(320)} = 0.625$		
B) Compute $R_n = \frac{M_n}{f'_c A_g h}$	$R_n = \frac{5600}{(4)(320)(20)} = 0.22$		
C) Estimate $\gamma \approx \frac{h - 5}{h}$	$\gamma \approx \frac{20 - 5}{20} = 0.75$		
D) Determine the appropriate interaction diagram(s)	For a rectangular tied column with bars along four faces, $f'_c = 4$ ksi, $f_y = 60$ ksi, and an estimated γ of 0.75, use R4-60.7 and R4-60.8. For $k_n = 0.625$ and $R_n = 0.22$	10.2 10.3	
E) Read ρ_g for k_n and R_n values from appropriate interaction diagrams	Read $\rho_g = 0.041$ for $\gamma = 0.7$ and $\rho_g = 0.039$ for $\gamma = 0.8$ Interpolating; $\rho_g = 0.040$ for $\gamma = 0.75$		
F) Compute required A_{st} from $A_{st} = \rho_g A_g$	Required $A_{st} = 0.040 \times 320$ in. ² $= 12.8$ in. ²		Columns 3.2.2 (R4-60.7) and 3.2.3 (R4-60.8)

COLUMNS EXAMPLE 2 - For a specified reinforcement ratio, selection of a column section size for a rectangular tied column with bars on end faces only

For minimum longitudinal reinforcement ($\rho_g = 0.01$) and column section dimension $h = 16$ in., select the column dimension b for a rectangular tied column with bars on end faces only.

Given: Loading

$P_u = 660$ kips and $M_u = 2790$ kip-in.
 Assume $\phi = 0.70$ or,
 Nominal axial load $P_n = 660/0.70 = 943$ kips
 Nominal moment $M_n = 4200/0.70 = 3986$ kip-in.

Materials

Compressive strength of concrete $f'_c = 4$ ksi
 Yield strength of reinforcement $f_y = 60$ ksi
 Nominal maximum size of aggregate is 1 in.

Design conditions

Slenderness effects may be neglected because $k \ell_u/h$ is known to be below critical value

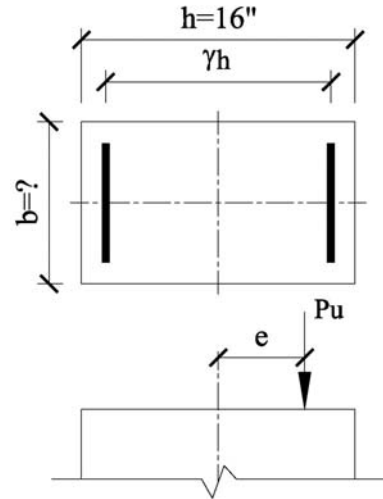

Procedure	Calculation	ACI 318-05 Section	Design Aid
Determine trial column dimension b corresponding to known values of variables on appropriate interaction diagram(s).	$P_n = 943$ kips, $M_n = 3986$ kip-in. $h = 16$ in. $f'_c = 4$ ksi, $f_y = 60$ ksi $\rho_g = 0.01$		
A) Assume a series of trial column sizes b , in inches; and compute $A_g = b \times h$, in. ²	24 26 28 384 416 448		
B) Compute $K_n = \frac{P_n}{f'_c A_g}$	$\frac{943}{(4)(384)}$ $\frac{943}{(4)(416)}$ $\frac{943}{(4)(448)}$ = 0.61 = 0.57 = 0.53		
C) Compute $R_n = \frac{M_n}{f'_c A_g h}$	$\frac{3986}{(4)(384)(16)}$ $\frac{3986}{(4)(416)(16)}$ $\frac{3986}{(4)(448)(16)}$ = 0.16 = 0.14 = 0.14		
D) Estimate $\gamma \approx \frac{h-5}{h}$	0.7 0.7 0.7		
D) Determine the appropriate interaction diagram(s)	For a rectangular tied column with bars along four faces, $f'_c = 4$ ksi, $f_y = 60$ ksi, and an estimated γ of 0.70, use Interaction Diagram L4-60.7		
E) Read ρ_g for k_n and R_n values For $\gamma = 0.7$, select dimension corresponding to ρ_g nearest desired value of $\rho_g = 0.01$	0.018 0.014 0.011	10.2 10.3	Columns 3.8.2 (L4-60.7)
	Therefore, try a 16 x 28-in. column		

COLUMNS EXAMPLE 3 - Selection of reinforcement for a square spiral column (slenderness ratio is below critical value)

For the square spiral column section shown, select reinforcement.

Given: Loading

$P_u = 660$ kips and $M_u = 2640$ kip-in.
 Assume $\phi = 0.70$ or,
 Nominal axial load $P_n = 660/0.70 = 943$ kips
 Nominal moment $M_n = 2640/0.70 = 3771$ kip-in.

Materials

Compressive strength of concrete $f'_c = 4$ ksi
 Yield strength of reinforcement $f_y = 60$ ksi
 Nominal maximum size of aggregate is 1 in.

Design conditions

Column section size $h = b = 18$ in
 Slenderness effects may be neglected because
 $k \ell_u/h$ is known to be below critical value

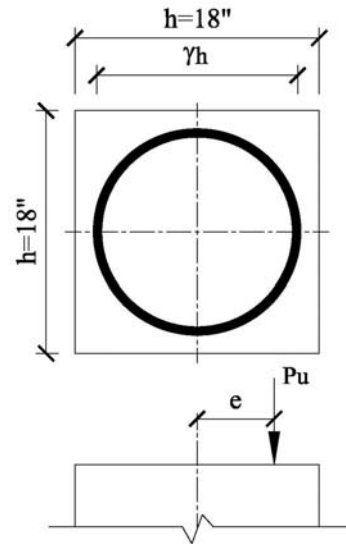

Procedure	Calculation	ACI 318-05 Section	Design Aid
Determine reinforcement ratio ρ_g using known values of variables on appropriate interaction diagram(s) and compute required cross section area A_{st} of longitudinal reinforcement. A) Compute $K_n = \frac{P_n}{f'_c A_g}$ B) Compute $R_n = \frac{M_n}{f'_c A_g h}$ C) Estimate $\gamma \approx \frac{h-5}{h}$ D) Determine the appropriate interaction diagram(s) E) Read ρ_g for k_n and R_n values.	$P_n = 943$ kips $M_n = 3771$ kip-in. $h = 18$ in. $b = 18$ in. $A_g = b \times h = 18 \times 18 = 324$ in. ² $K_n = \frac{943}{(4)(324)} = 0.73$ $R_n = \frac{3771}{(4)(320)(18)} = 0.16$ $\gamma \approx \frac{18-5}{18} = 0.72$ For a square spiral column, $f'_c = 4$ ksi, $f_y = 60$ ksi, and an estimated γ of 0.72, use Interaction Diagram S4-60.7 and S4-60.8 For $k_n = 0.73$ and $R_n = 0.16$ and, $\gamma = 0.70: \rho_g = 0.035$ $\gamma = 0.80: \rho_g = 0.031$ for $\gamma = 0.72: \rho_g = 0.034$ $A_{st} = 0.034 \times 320$ in. ² = 12.8 in ²	10.2 10.3	Columns 3.20.2 (S4-60.7) and 3.20.3 (S4-60.8)

COLUMNS EXAMPLE 4 - Design of square column section subject to biaxial bending using resultant moment

Select column section size and reinforcement for a square column with $\rho_g \leq 0.04$ and bars equally distributed along four faces, subject to biaxial bending.

Given: Loading

$P_u = 193$ kip, $M_{ux} = 1917$ kip-in., and $M_{uy} = 769$ kip-in.

Assume $\phi = 0.65$ or,

Nominal axial load $P_n = 193/0.65 = 297$ kips

Nominal moment about x-axis $M_{nx} = 1917/0.65 = 2949$ kip-in.

Nominal moment about y-axis $M_{ny} = 769/0.65 = 1183$ kip-in.

Materials

Compressive strength of concrete $f'_c = 5$ ksi

Yield strength of reinforcement $f_y = 60$ ksi

Nominal maximum size of aggregate is 1 in.

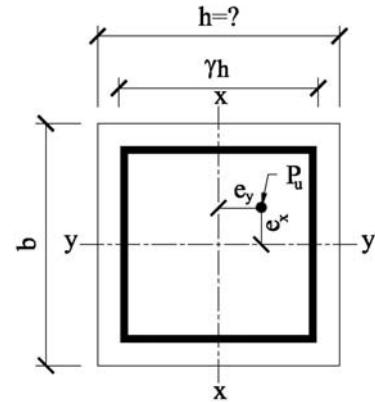

Procedure	Calculation	ACI 318-05 Section	Design Aid
Assume load contour curve at constant P_n is an ellipse, and determine resultant moment M_{nr} from $M_{nr} = \sqrt{M_{nx}^2 + M_{ny}^2}$	For a square column: $h=b$ $M_{nr} = \sqrt{(2949)^2 + (1183)^2} = 3177$ kip-in.		
A) Assume a series of trial column sizes h , in inches.	14 16 18		
B) Compute $A_g = h^2$, in. ²	196 256 324		
C) Compute $K_n = \frac{P_n}{f'_c A_g}$	$\frac{297}{(5)(196)}$ $\frac{297}{(5)(256)}$ $\frac{297}{(5)(324)}$ = 0.30 = 0.23 = 0.18		
D) Compute $R_n = \frac{M_n}{f'_c A_g h}$	$\frac{3177}{(5)(196)(14)}$ $\frac{3177}{(5)(256)(16)}$ $\frac{3177}{(5)(324)(18)}$ = 0.23 = 0.16 = 0.11		
E) Estimate $\gamma \approx \frac{h-5}{h}$	0.64 0.69 0.72		
F) Determine the appropriate interaction diagram(s)	For a rectangular tied column with $f'_c = 5$ ksi, $f_y = 60$ ksi. Use Interaction Diagrams R5-60.6, R5-60.7, and R5-60.8.		Columns 3.3.1 (R5-60.6), 3.3.2 (R5-60.7), and 3.3.3 (R5-60.8)
E) Read ρ_g for R_n and k_n values , For $\gamma = 0.60$, For $\gamma = 0.70$, and For $\gamma = 0.80$	0.064 0.030 0.012 0.048 0.026 0.011		
Interpolating for γ in step E	0.058 0.026 0.012		
	Therefore, try $h = 15$ in.		

<p>Determine reinforcement ratio ρ_g using known values of variables on appropriate interaction diagram(s) and compute required cross section area A_{st} of longitudinal reinforcement.</p> <p>A) Compute $K_n = \frac{P_n}{f'_c A_g}$</p> <p>B) Compute $R_n = \frac{M_n}{f'_c A_g h}$</p> <p>C) Estimate $\gamma \approx \frac{h-5}{h}$</p> <p>D) Determine the appropriate interaction diagram(s)</p> <p>E) Read ρ_g for k_n and R_n values from appropriate interaction diagrams</p> <p>F) Compute required A_{st} from $A_{st} = \rho_g A_g$ and add about 15 percent for skew bending</p>	<p>$A_g = h^2 = (15)^2 = 225 \text{ in.}^2$ $P_n = 297 \text{ kip}$ $M_n = 3177 \text{ kip-in.}$</p> <p>$K_n = \frac{297}{(5)(225)} = 0.264$</p> <p>$R_n = \frac{3177}{(5)(225)(15)} = 0.188$</p> <p>$\gamma \approx \frac{15-5}{15} = 0.67$</p> <p>For a rectangular tied column with $f'_c = 5$ ksi, $f_y = 60$ ksi, and $\gamma = 0.67$. Use Interaction R5-60.6 and R5-60.7. For $k_n = 0.264$, $R_n = 0.188$, and</p> <table style="margin-left: 40px;"> <tr> <td style="padding-right: 10px;">$\gamma = 0.60:$</td> <td style="border-left: 1px solid black; padding-left: 10px;">$\rho_g = 0.043$</td> </tr> <tr> <td style="padding-right: 10px;">$\gamma = 0.70:$</td> <td style="border-left: 1px solid black; padding-left: 10px;">$\rho_g = 0.034$</td> </tr> <tr> <td style="padding-right: 10px;">for $\gamma = 0.67:$</td> <td style="border-left: 1px solid black; padding-left: 10px;">$\rho_g = 0.037$</td> </tr> </table> <p>Required $A_{st} = 0.037 \times 225 \text{ in.}^2$ $= 8.26 \text{ in.}^2$ Use $A_{st} \approx 9.50 \text{ in.}^2$</p>	$\gamma = 0.60:$	$\rho_g = 0.043$	$\gamma = 0.70:$	$\rho_g = 0.034$	for $\gamma = 0.67:$	$\rho_g = 0.037$	<p>10.2 10.3</p>	<p>Columns 3.3.1 (R5-60.6) and 3.3.2 (R5-60.7)</p>
$\gamma = 0.60:$	$\rho_g = 0.043$								
$\gamma = 0.70:$	$\rho_g = 0.034$								
for $\gamma = 0.67:$	$\rho_g = 0.037$								

<p>Determine reinforcement ratio ρ_g using known values of variables on appropriate interaction diagram(s) and compute required cross section area A_{st} of longitudinal reinforcement.</p> <p>A) Compute $K_n = \frac{P_n}{f'_c A_g}$</p> <p>B) Compute $R_n = \frac{M_n}{f'_c A_g h}$</p> <p>C) Estimate $\gamma \approx \frac{h - 5}{h}$</p> <p>D) Determine the appropriate interaction diagram(s)</p> <p>E) Read ρ_g for k_n and R_n values from appropriate interaction diagrams</p>	$A_g = \pi \left(\frac{17}{2} \right)^2 = 227 \text{ in.}^2$ $K_n = \frac{1343}{(5)(227)} = 1.18$ $R_n = \frac{686}{(5)(227)(17)} = 0.0356$ $\gamma \approx \frac{17 - 5}{17} = 0.71$ <p>For a circular column with $f'_c = 5$ ksi and $f_y = 60$ ksi. Use Interaction C5-60.7. For $k_n = 1.18$, $R_n = 0.0356$, and</p> $\gamma = 0.71: \quad \rho_g = 0.040$	<p>Columns</p>	<p>Columns 3.15.2 (C5-60.7)</p>
<p>F) Compute required A_{st} from $A_{st} = \rho_g A_g$</p>	<p>Required $A_{st} = 0.040 \times 227 \text{ in.}^2$ $= 9.08 \text{ in.}^2$</p>		

COLUMNS 3.1.1 - Nominal load-moment strength interaction diagram, R3-60.6

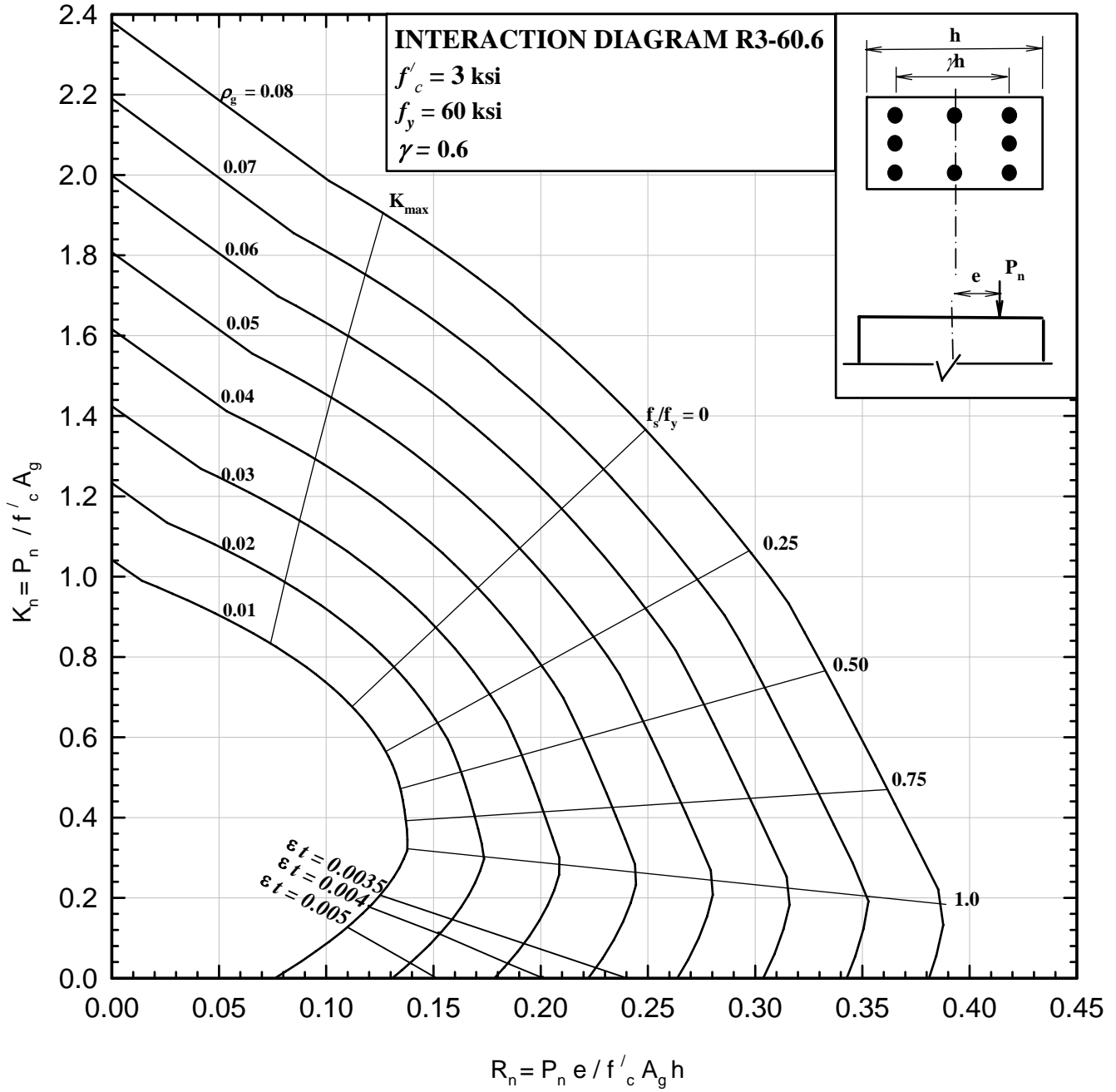

COLUMNS 3.1.2 - Nominal load-moment strength interaction diagram, R3-60.7

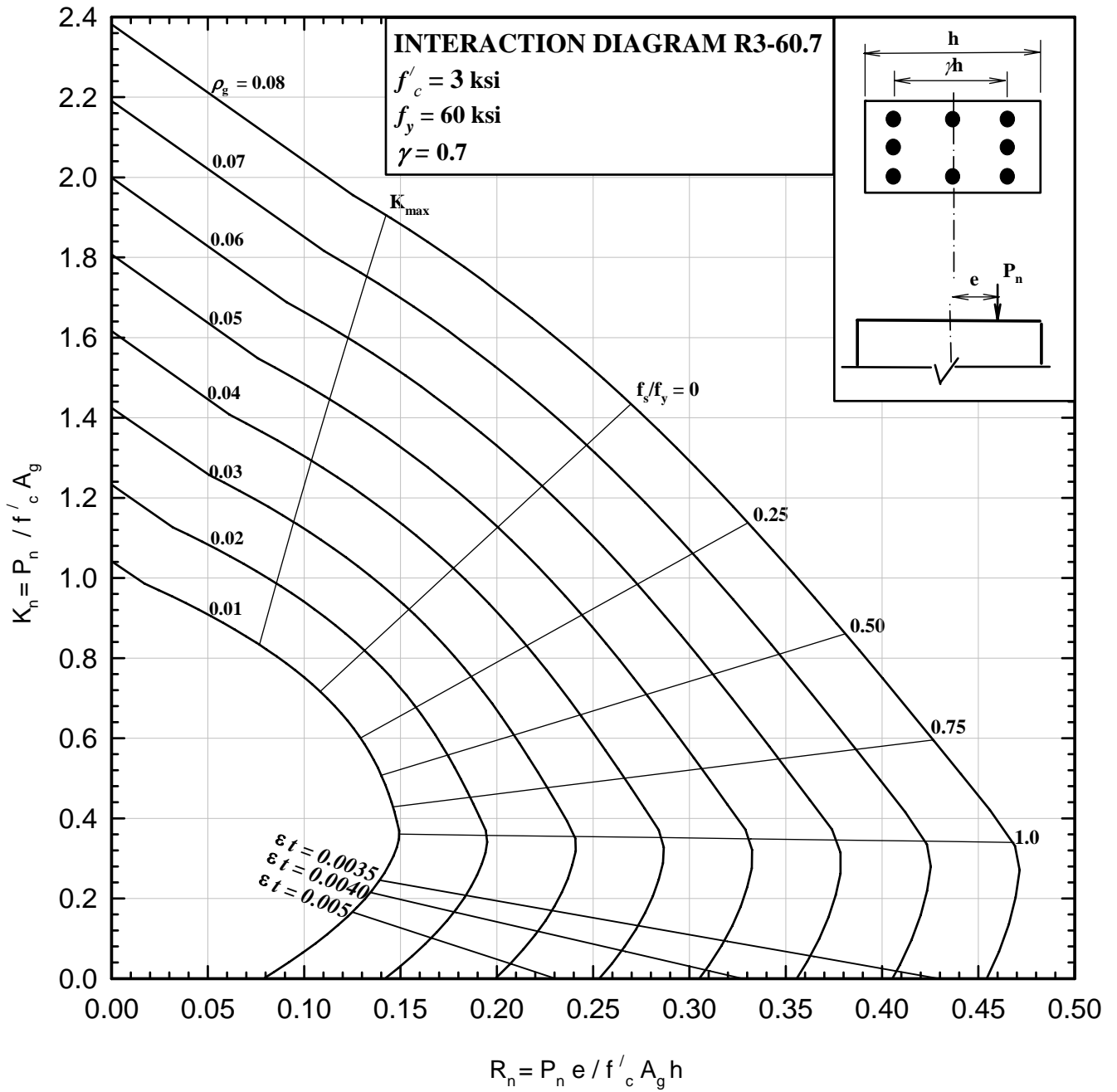

COLUMNS 3.1.3 - Nominal load-moment strength interaction diagram, R3-60.8

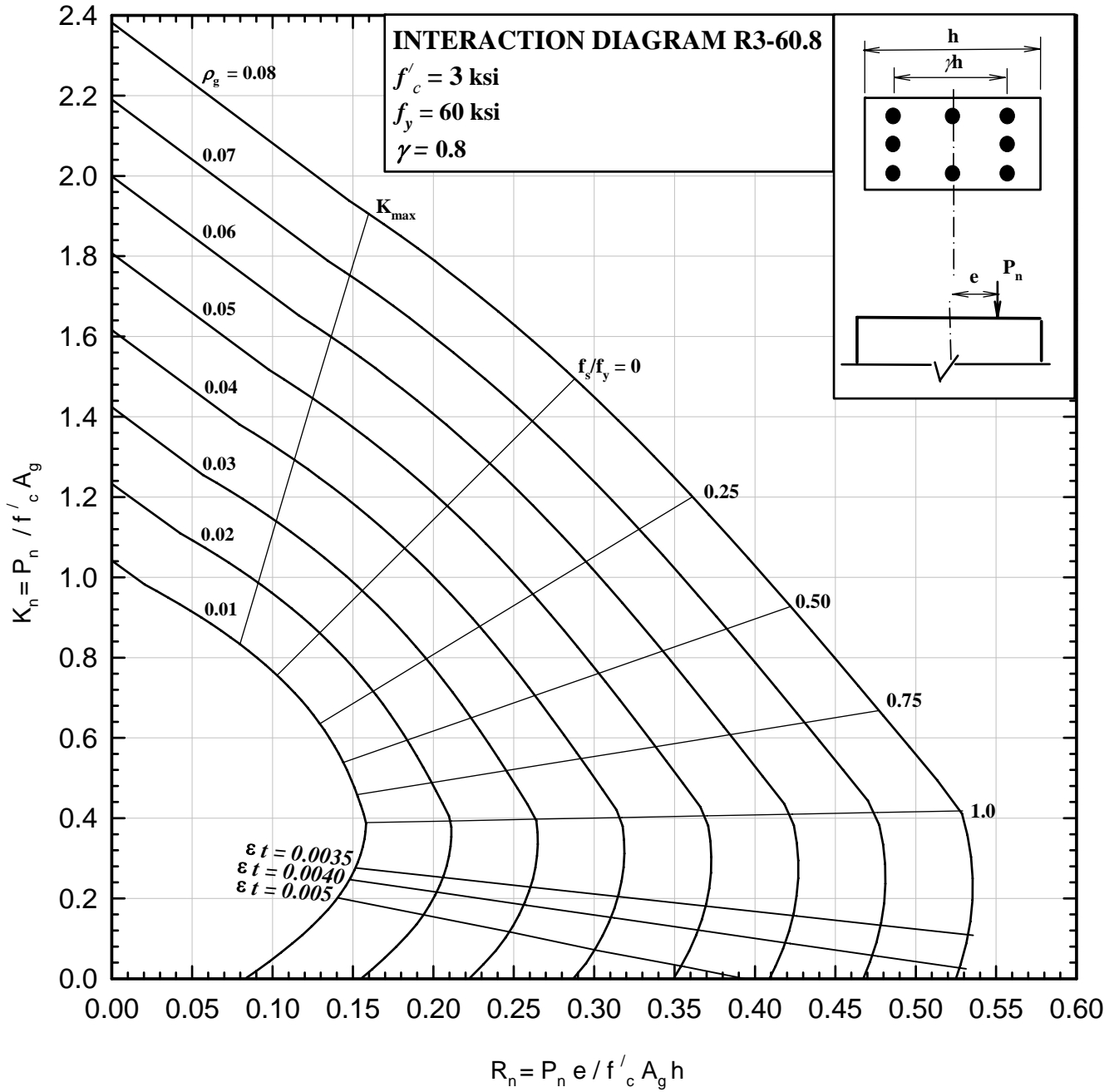

COLUMNS 3.1.4 - Nominal load-moment strength interaction diagram, R3-60.9

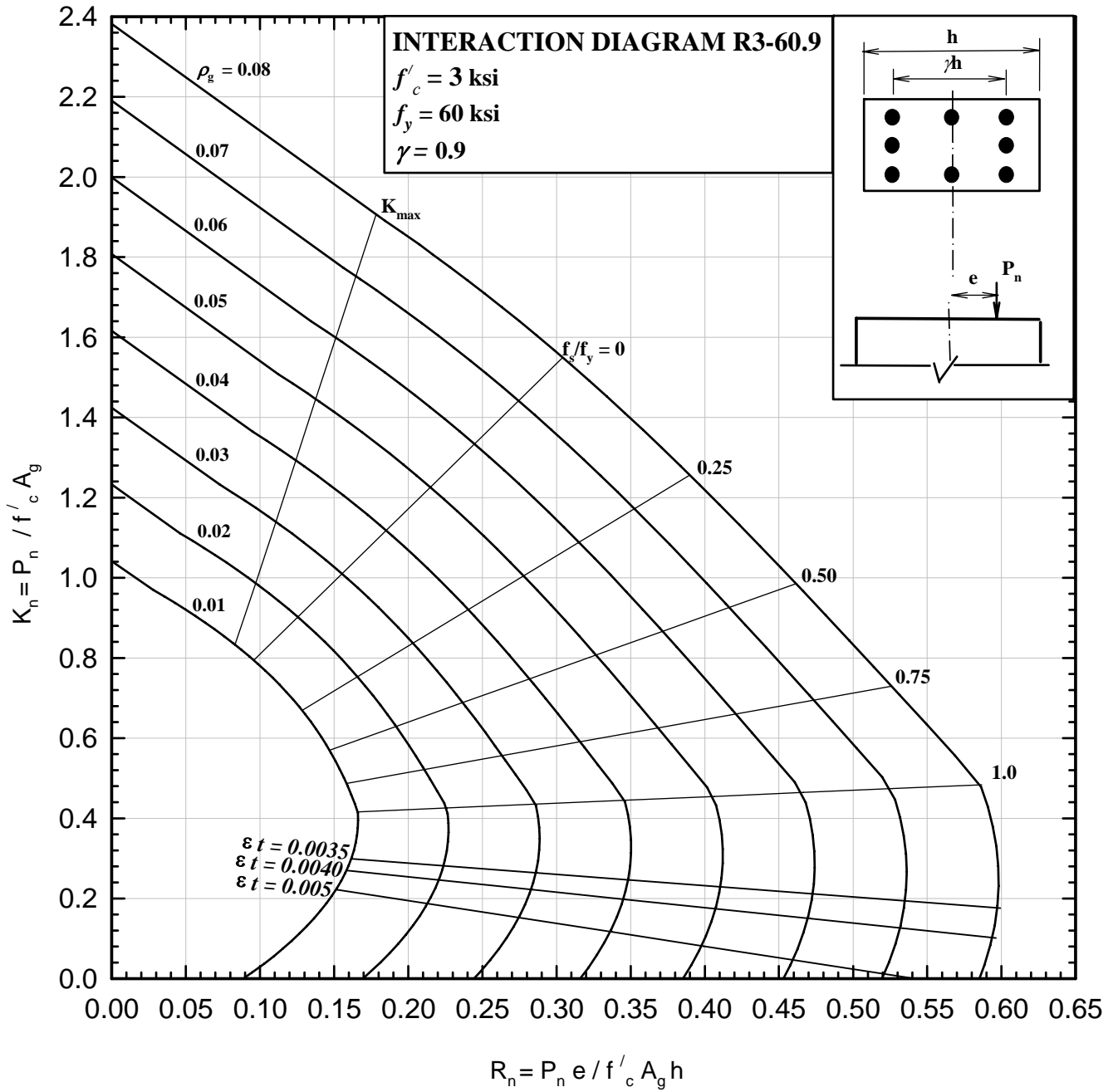

COLUMNS 3.2.1 - Nominal load-moment strength interaction diagram, R4-60.6

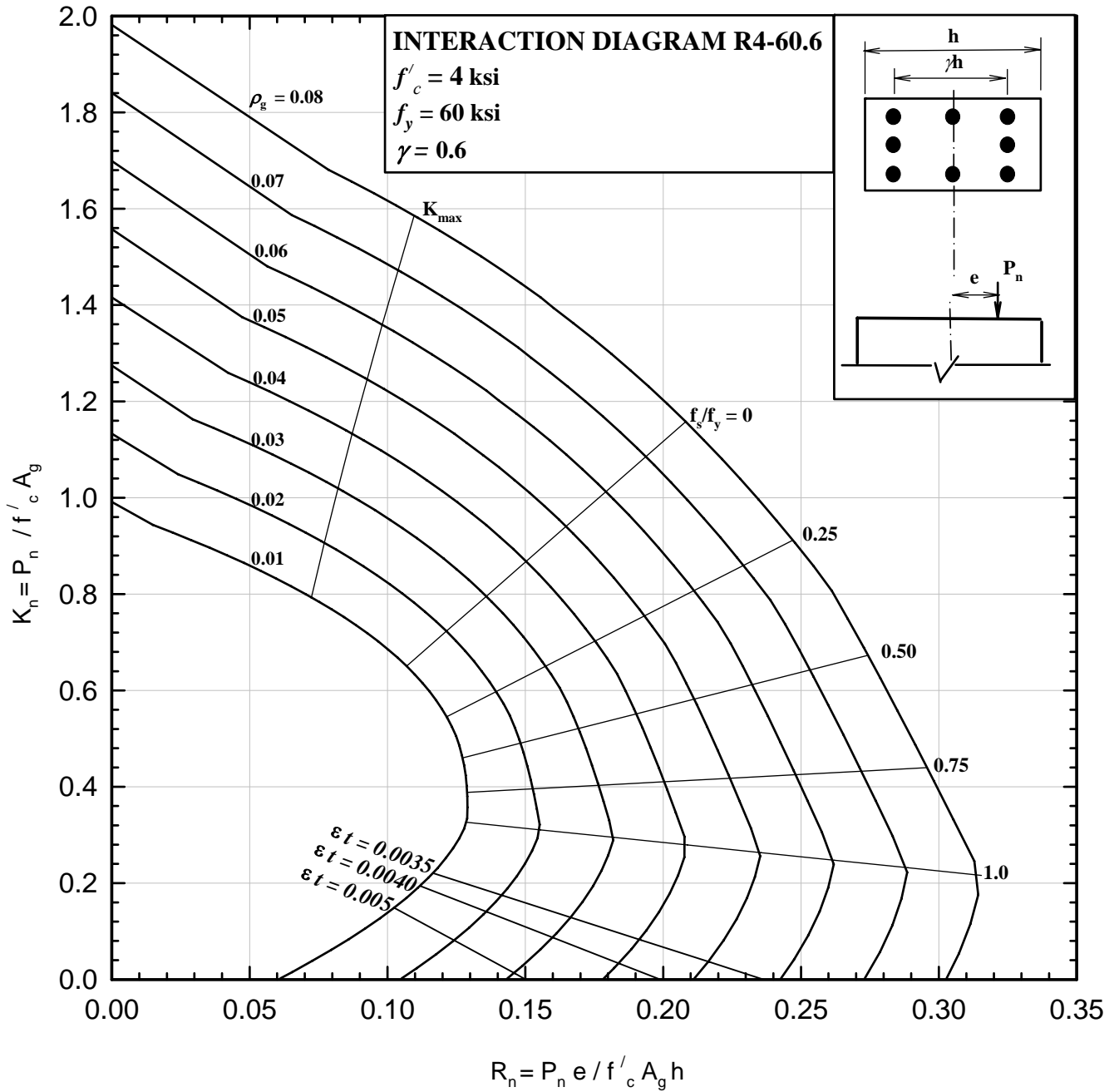

COLUMNS 3.2.2 - Nominal load-moment strength interaction diagram, R4-60.7

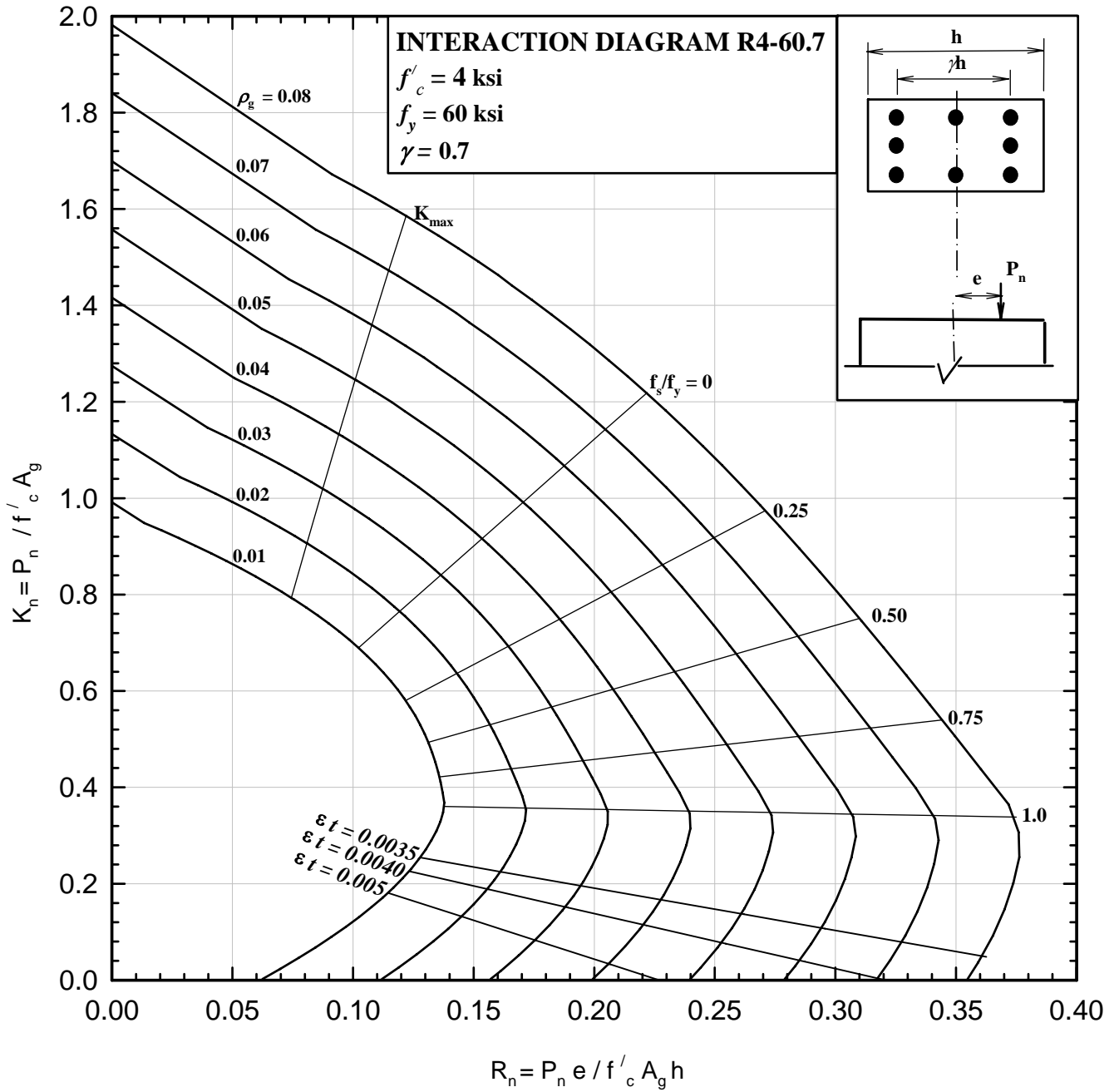

COLUMNS 3.2.3 - Nominal load-moment strength interaction diagram, R4-60.8

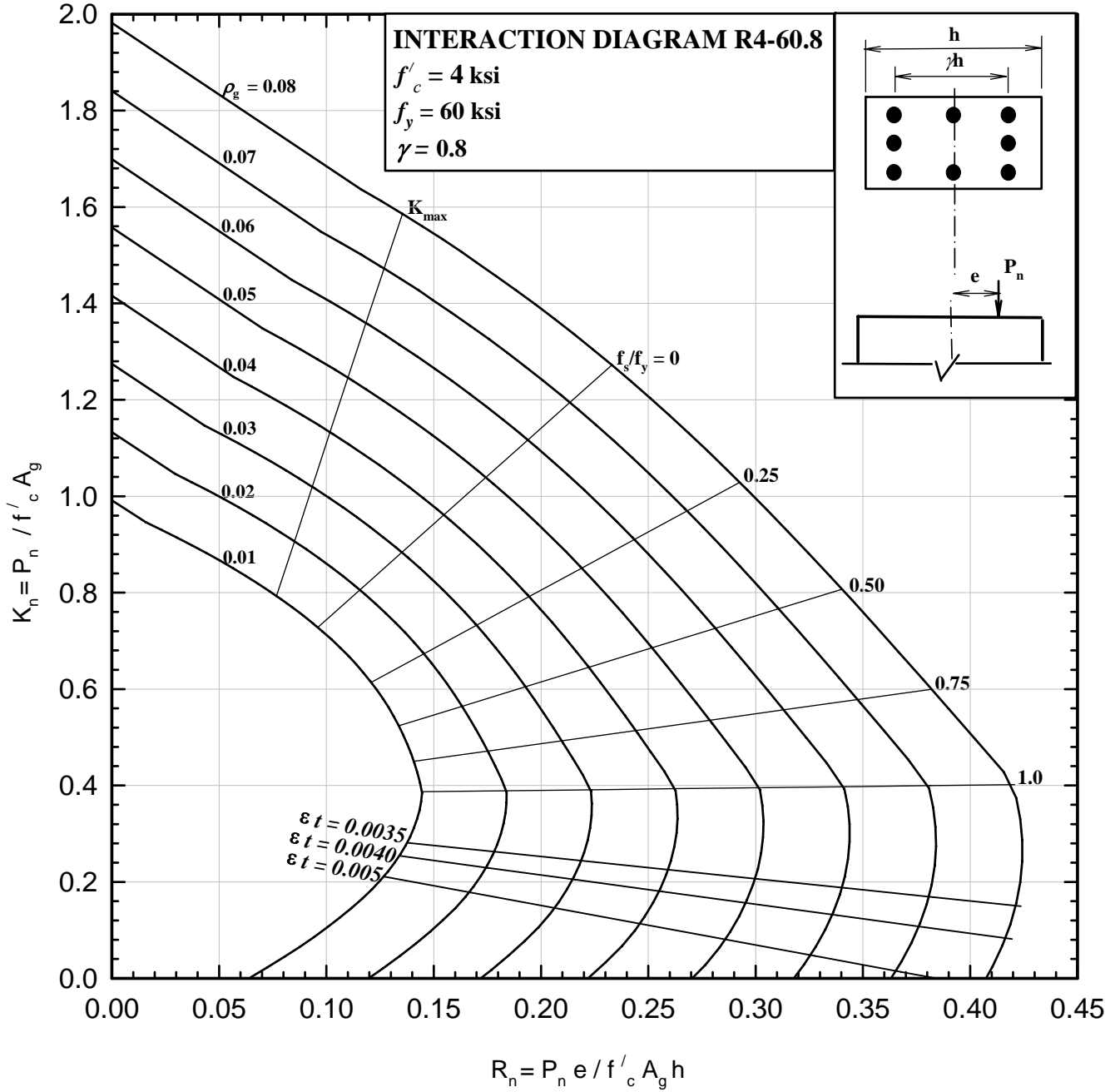

COLUMNS 3.2.4 - Nominal load-moment strength interaction diagram, R4-60.9

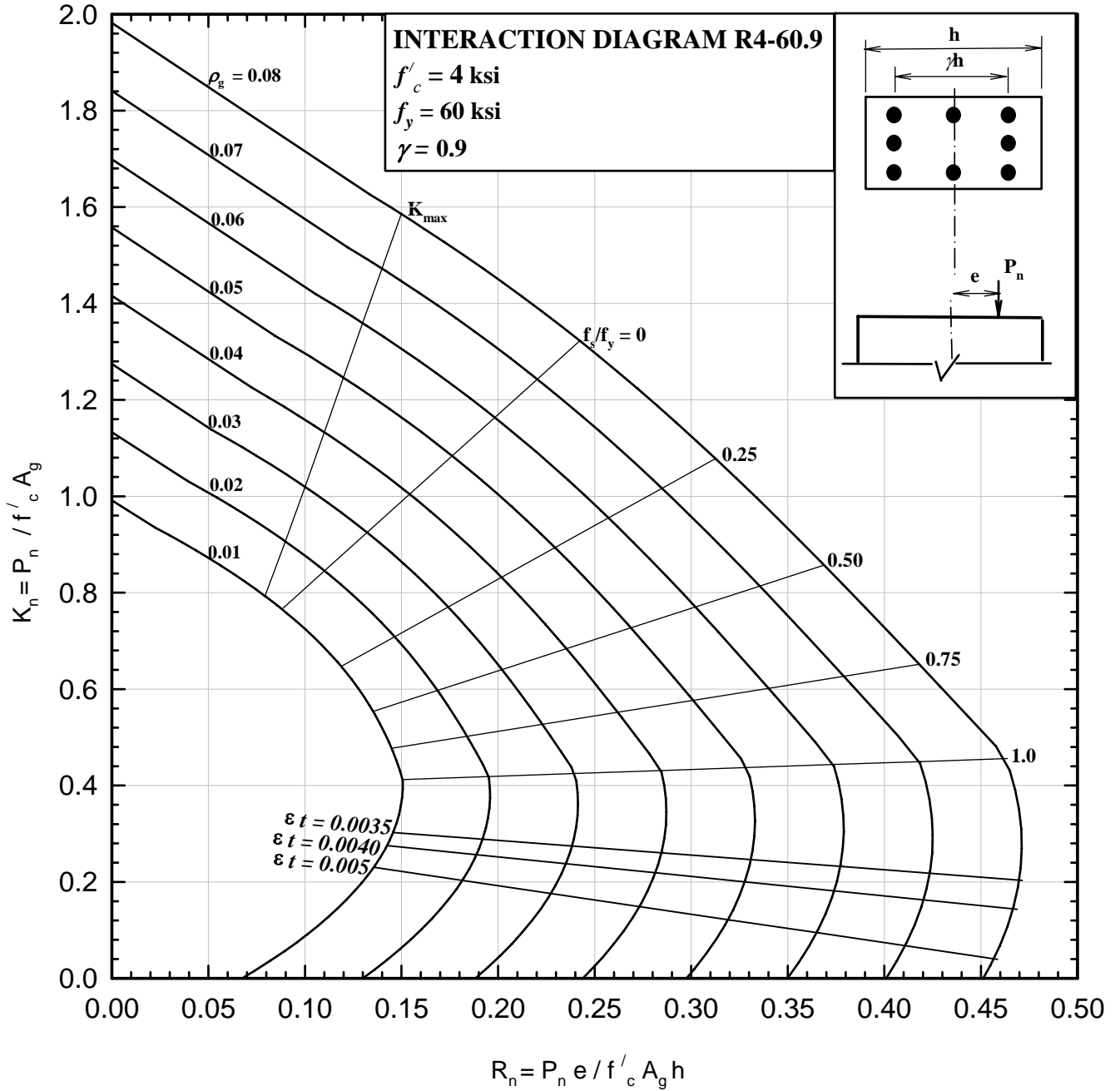

COLUMNS 3.3.1 - Nominal load-moment strength interaction diagram, R5-60.6

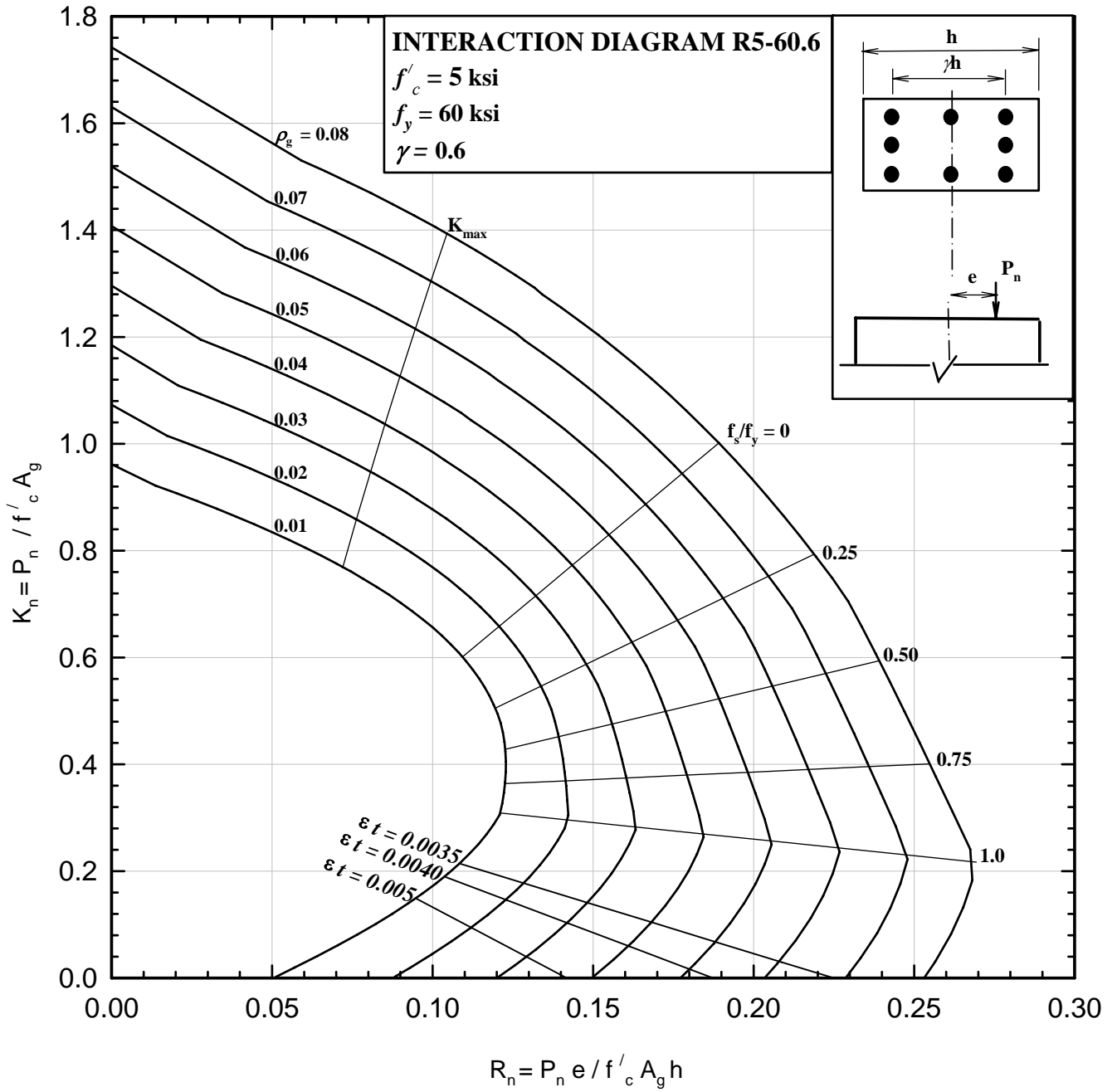

COLUMNS 3.3.2 - Nominal load-moment strength interaction diagram, R5-60.7

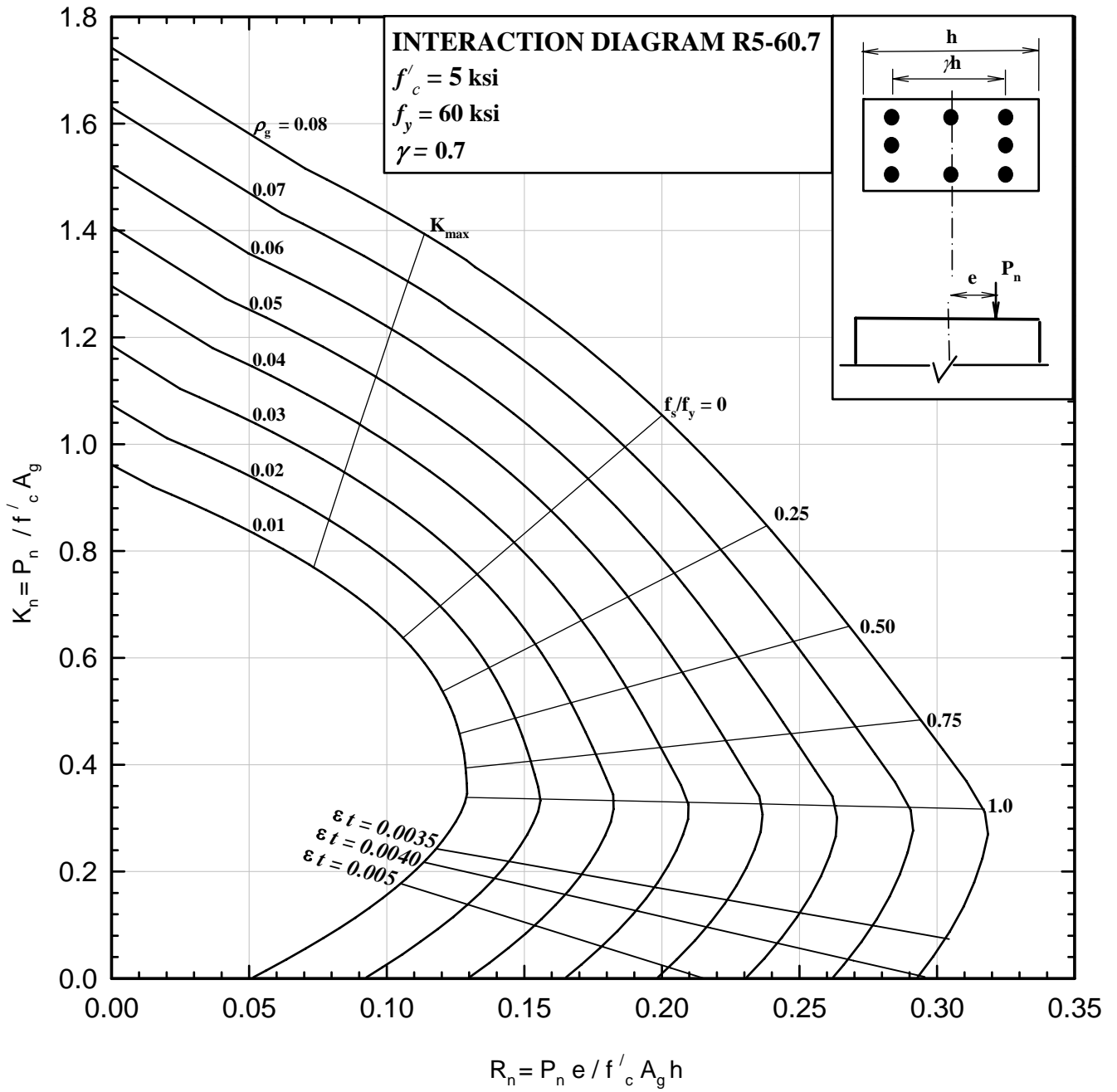

COLUMNS 3.3.3 - Nominal load-moment strength interaction diagram, R5-60.8

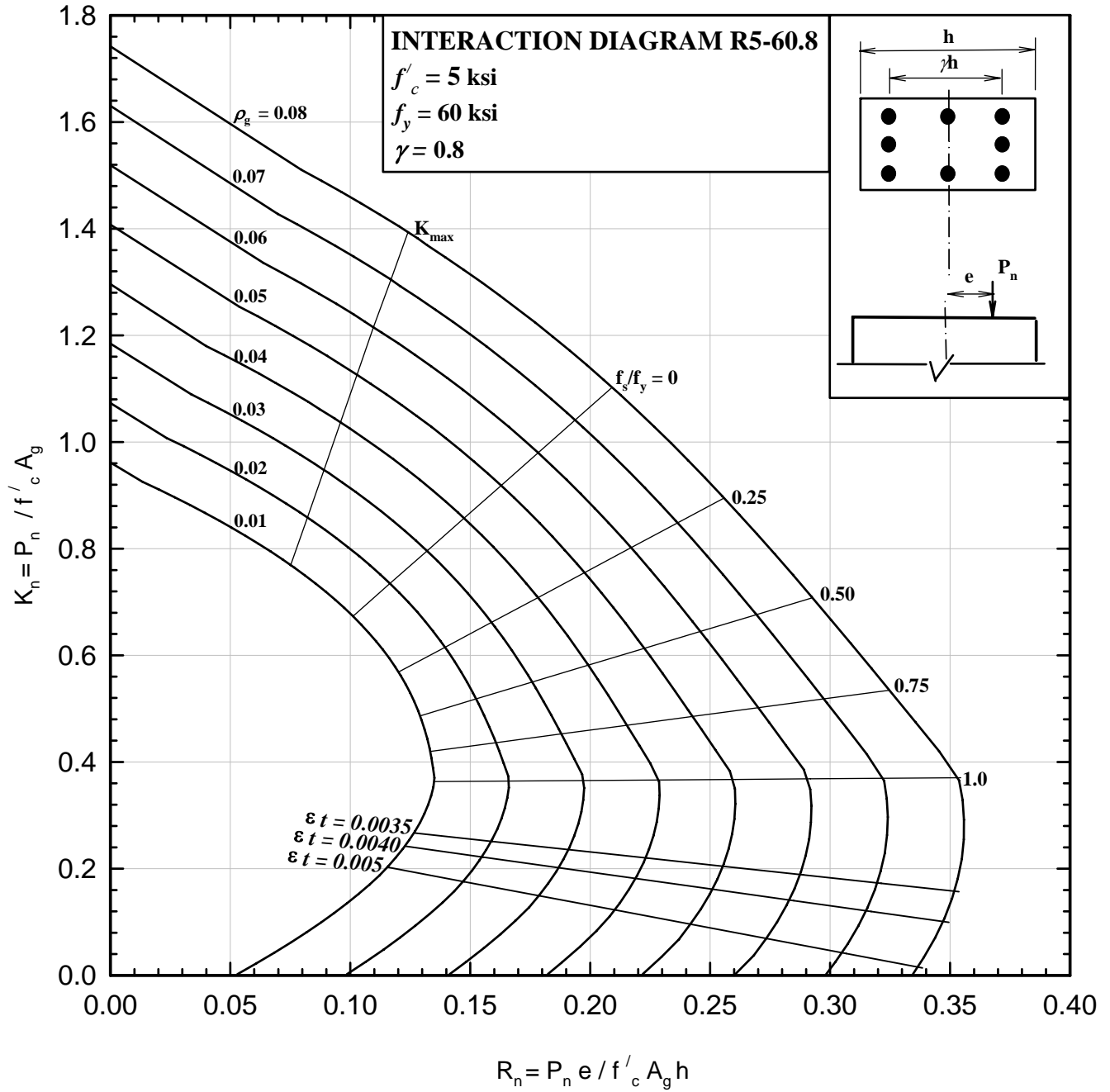

COLUMNS 3.3.4 - Nominal load-moment strength interaction diagram, R5-60.9

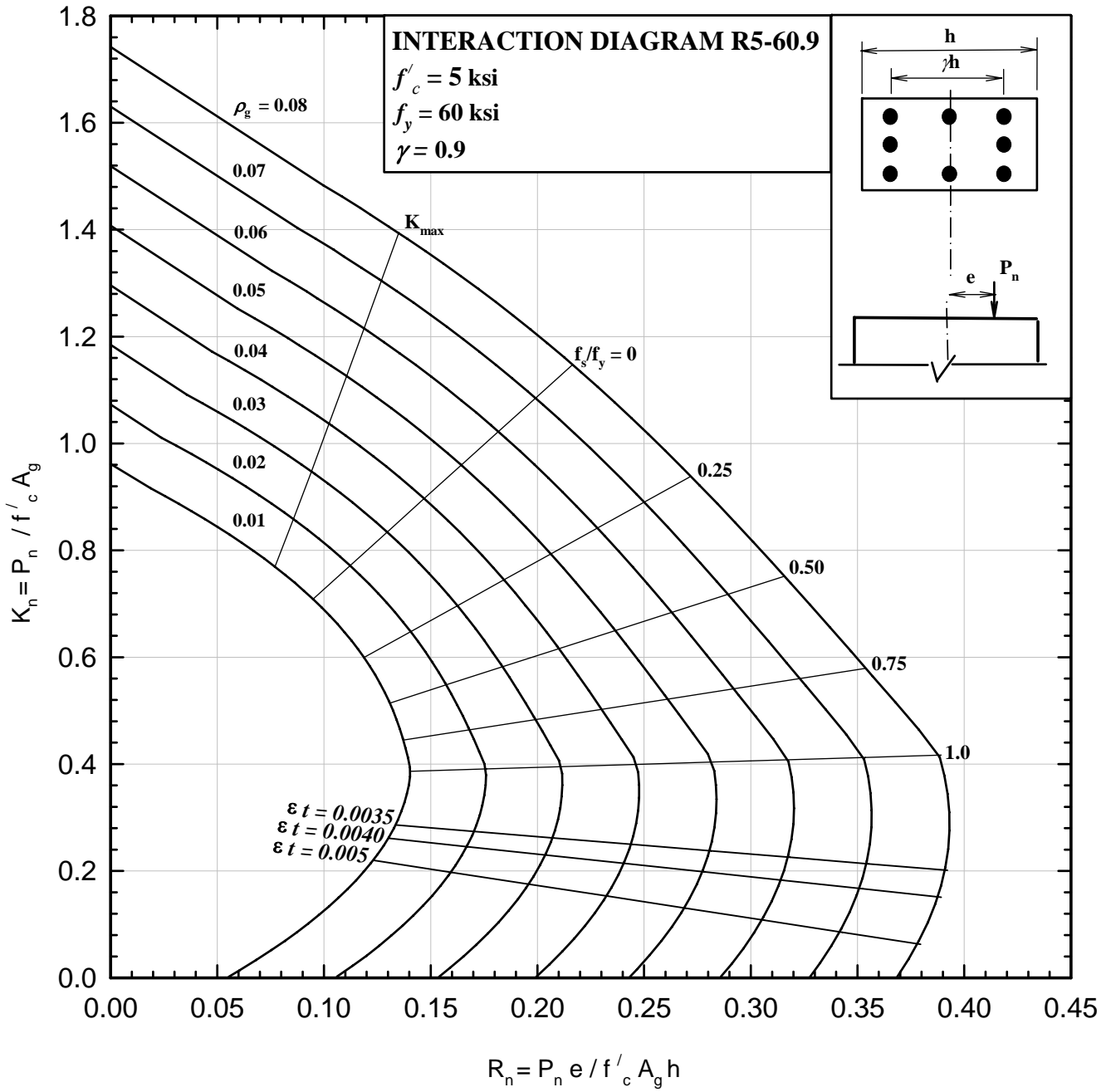

COLUMNS 3.4.1 - Nominal load-moment strength interaction diagram, R6-60.6

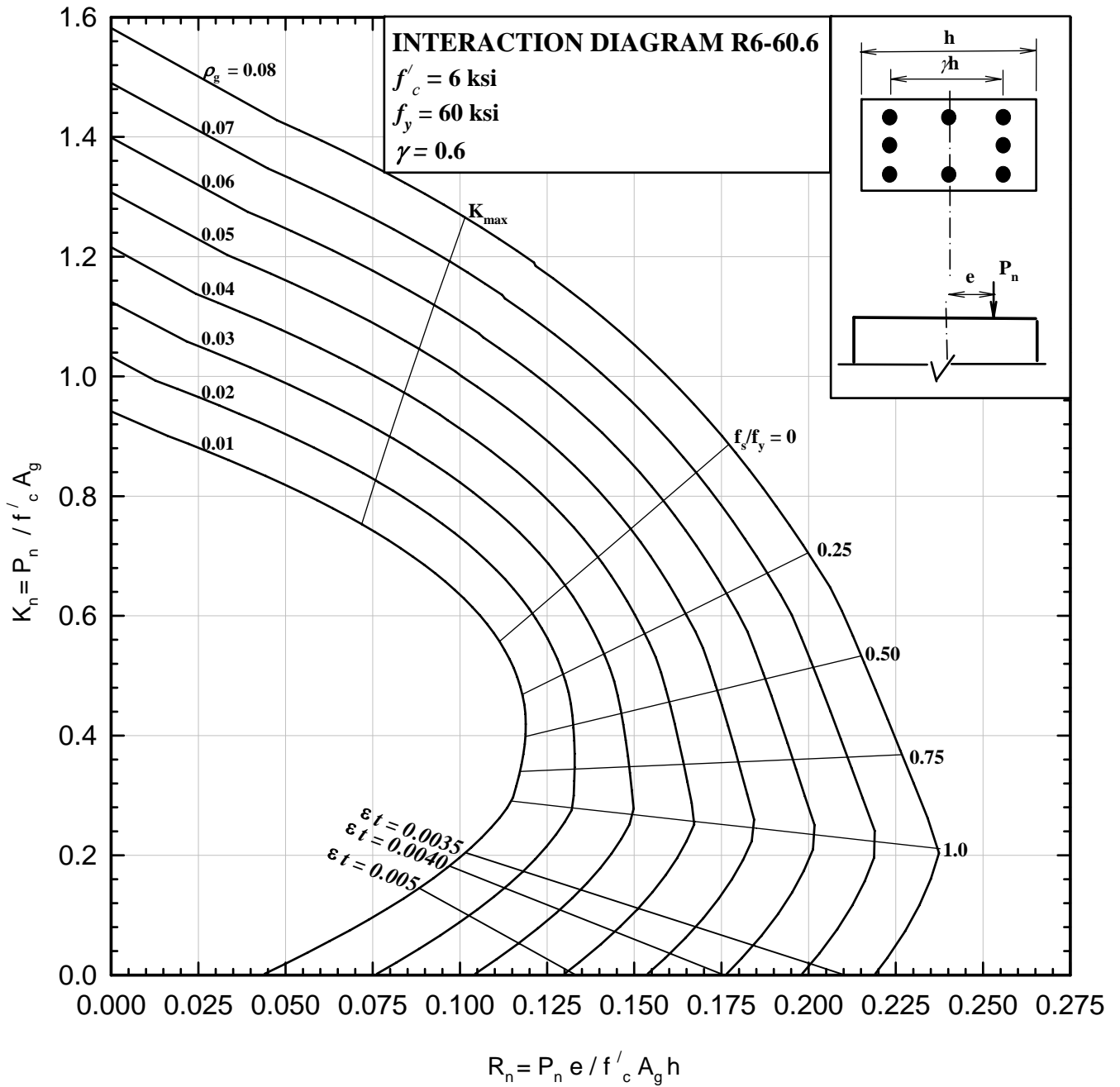

COLUMNS 3.4.2 - Nominal load-moment strength interaction diagram, R6-60.7

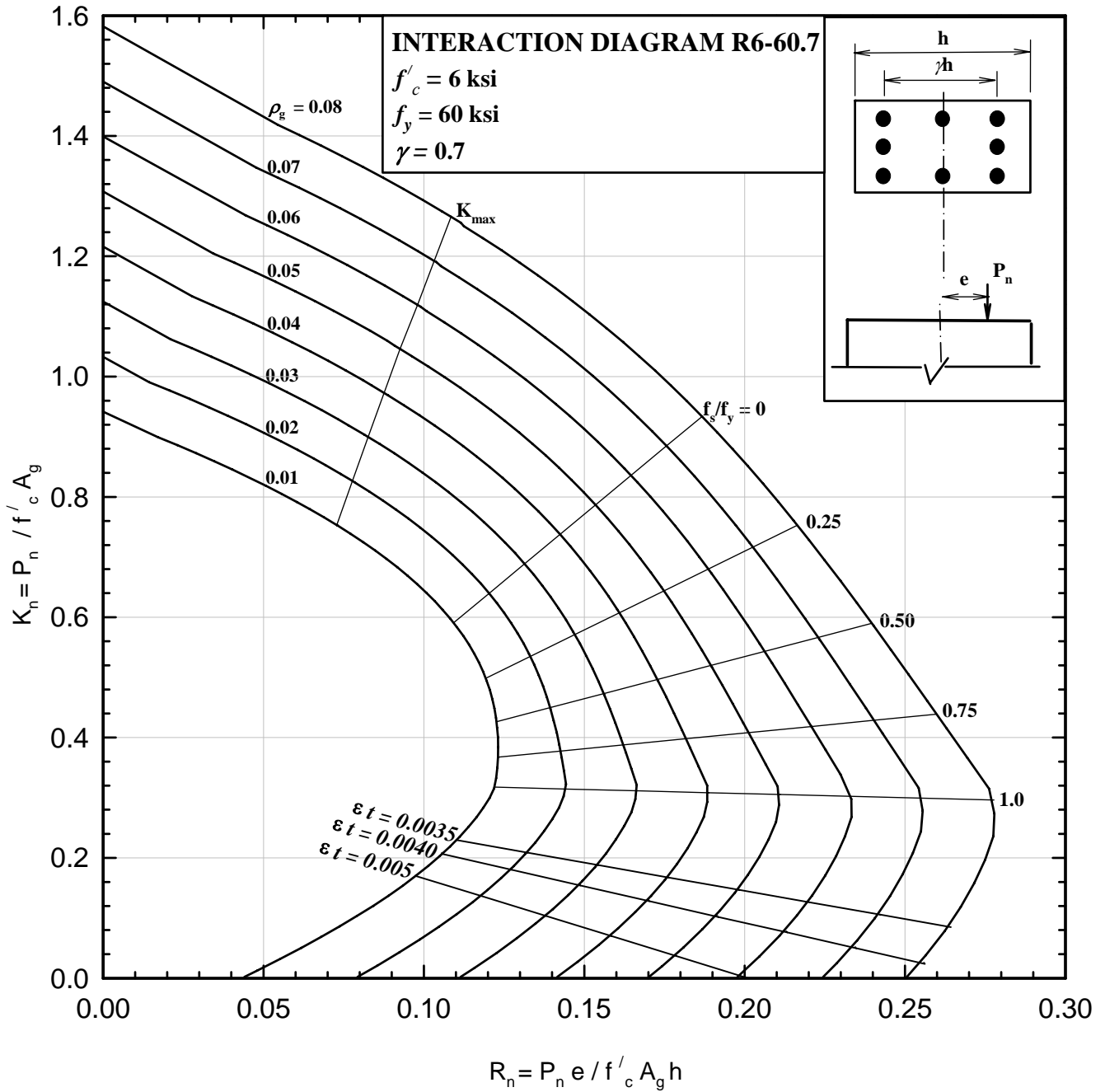

COLUMNS 3.4.3 - Nominal load-moment strength interaction diagram, R6-60.8

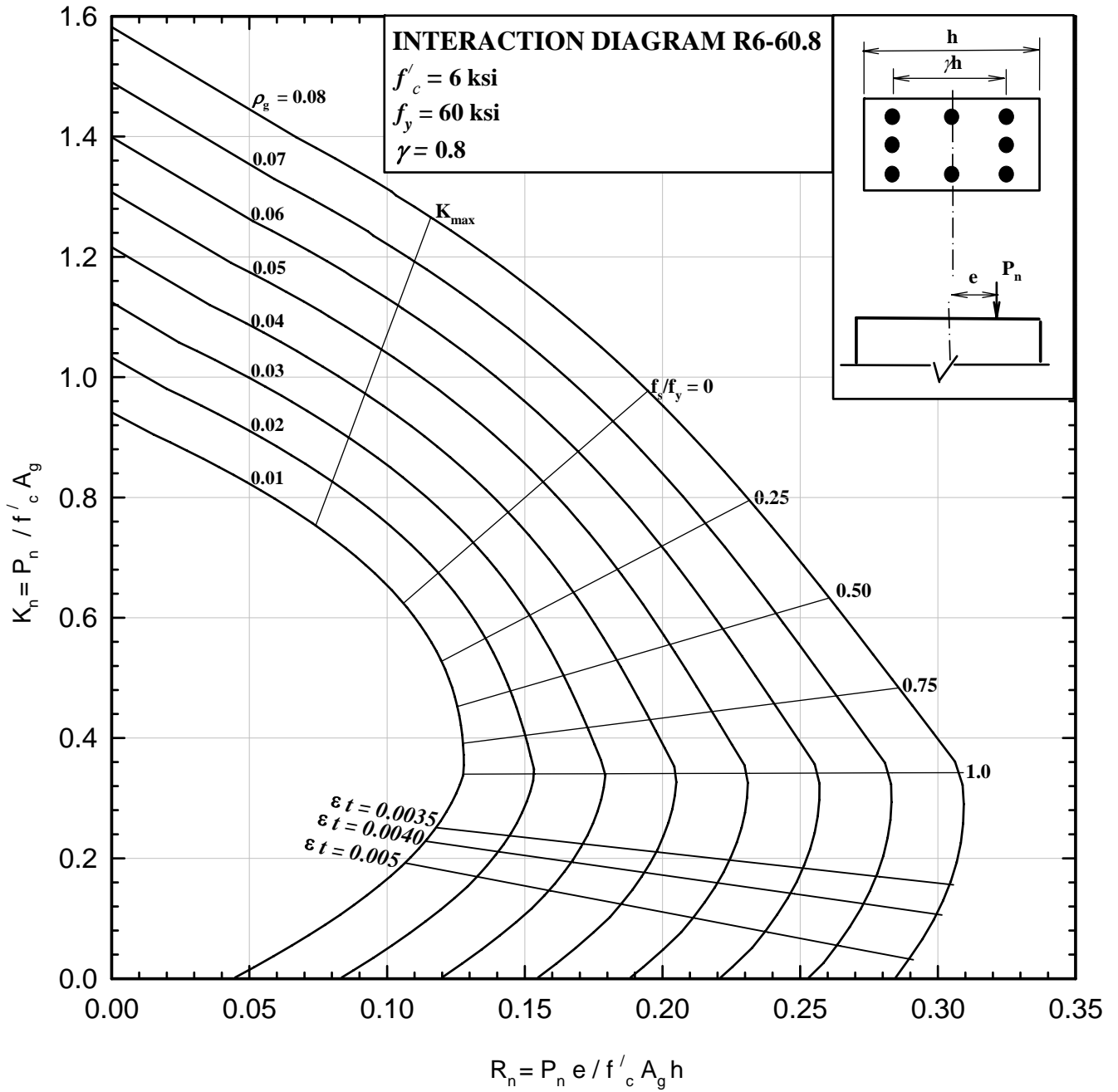

COLUMNS 3.4.4 - Nominal load-moment strength interaction diagram, R6-60.9

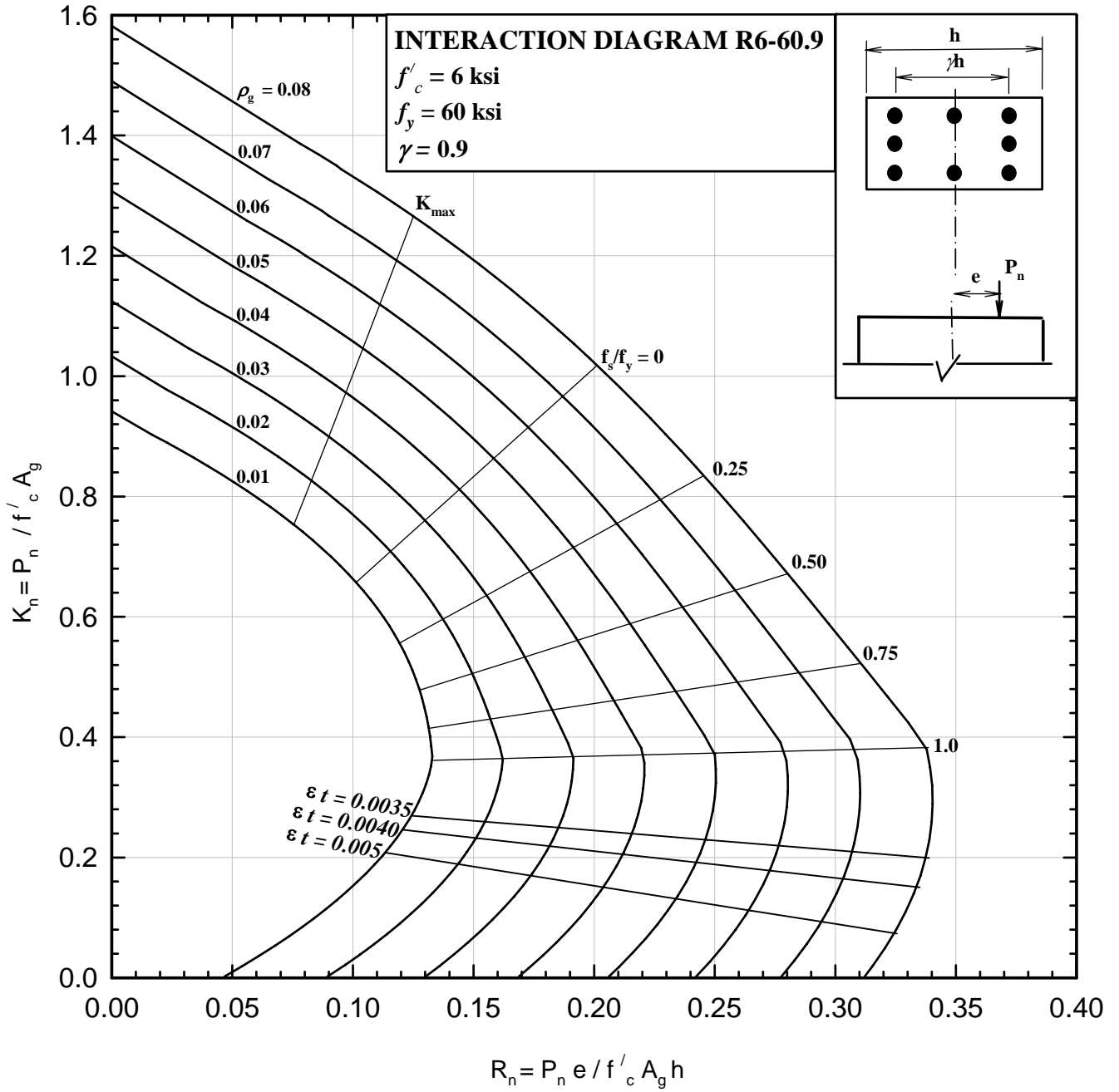

COLUMNS 3.5.1 - Nominal load-moment strength interaction diagram, R9-75.6

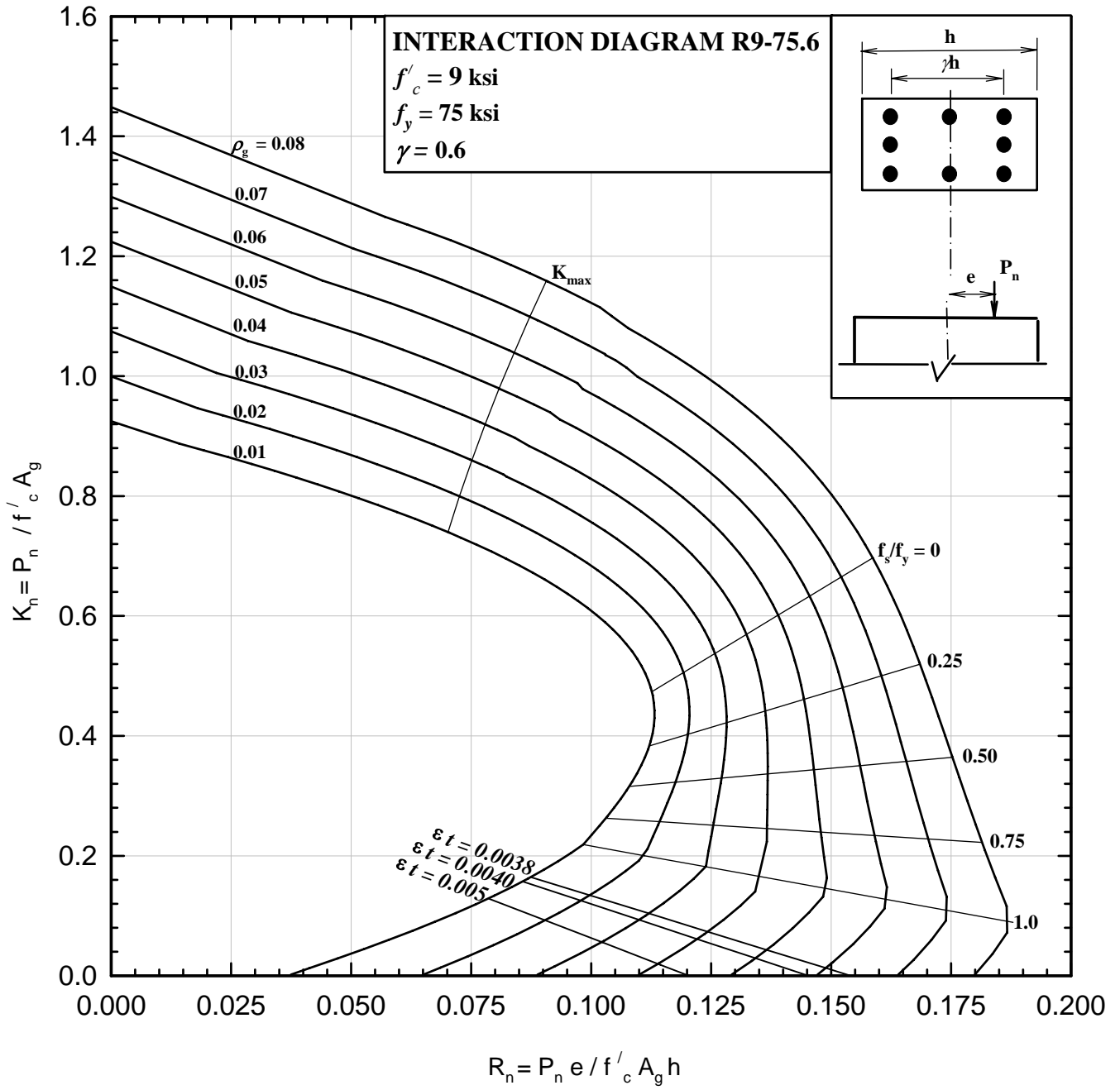

COLUMNS 3.5.2 - Nominal load-moment strength interaction diagram, R9-75.7

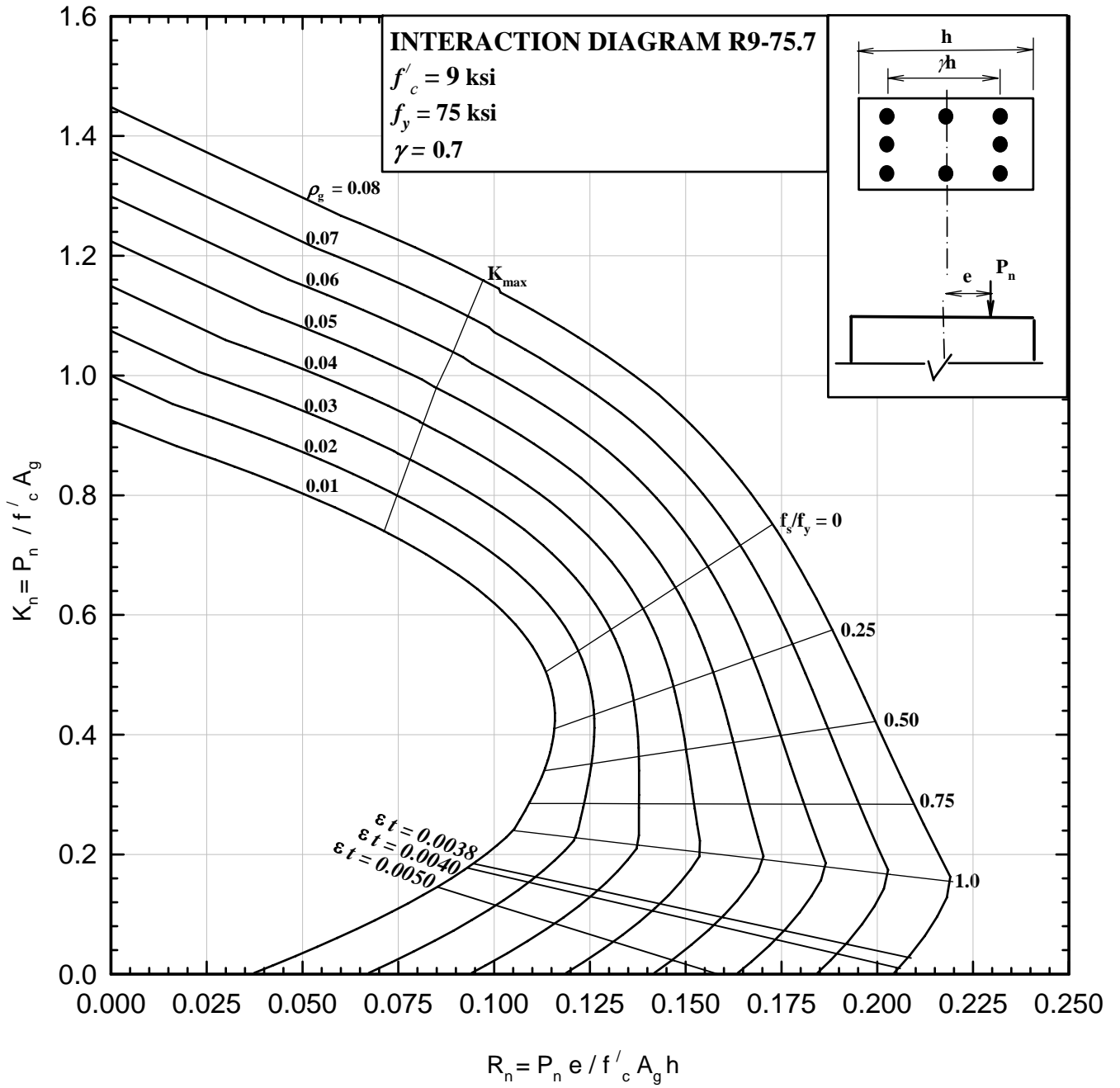

COLUMNS 3.5.3 - Nominal load-moment strength interaction diagram, R9-75.8

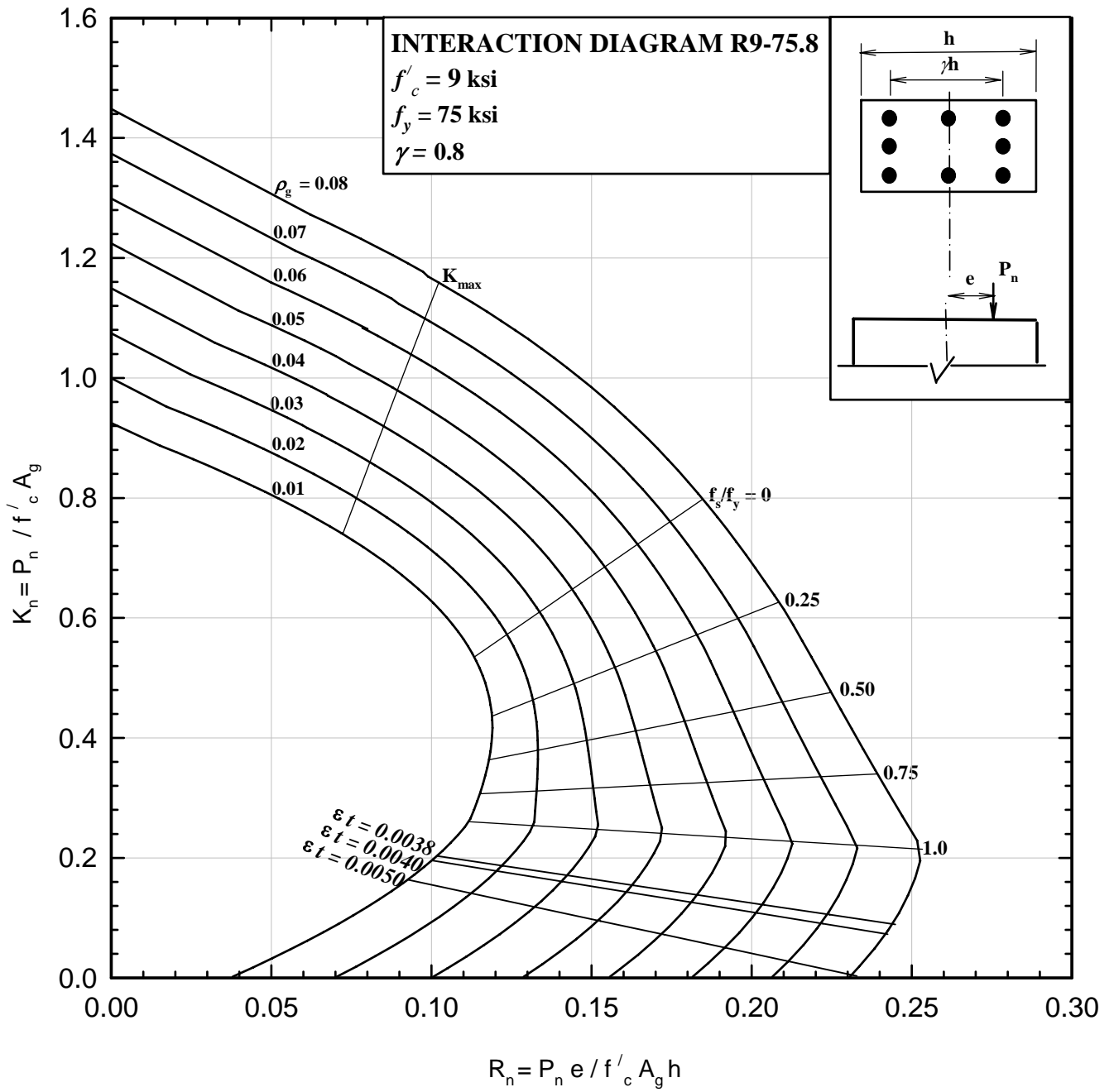

COLUMNS 3.5.4 - Nominal load-moment strength interaction diagram, R9-75.9

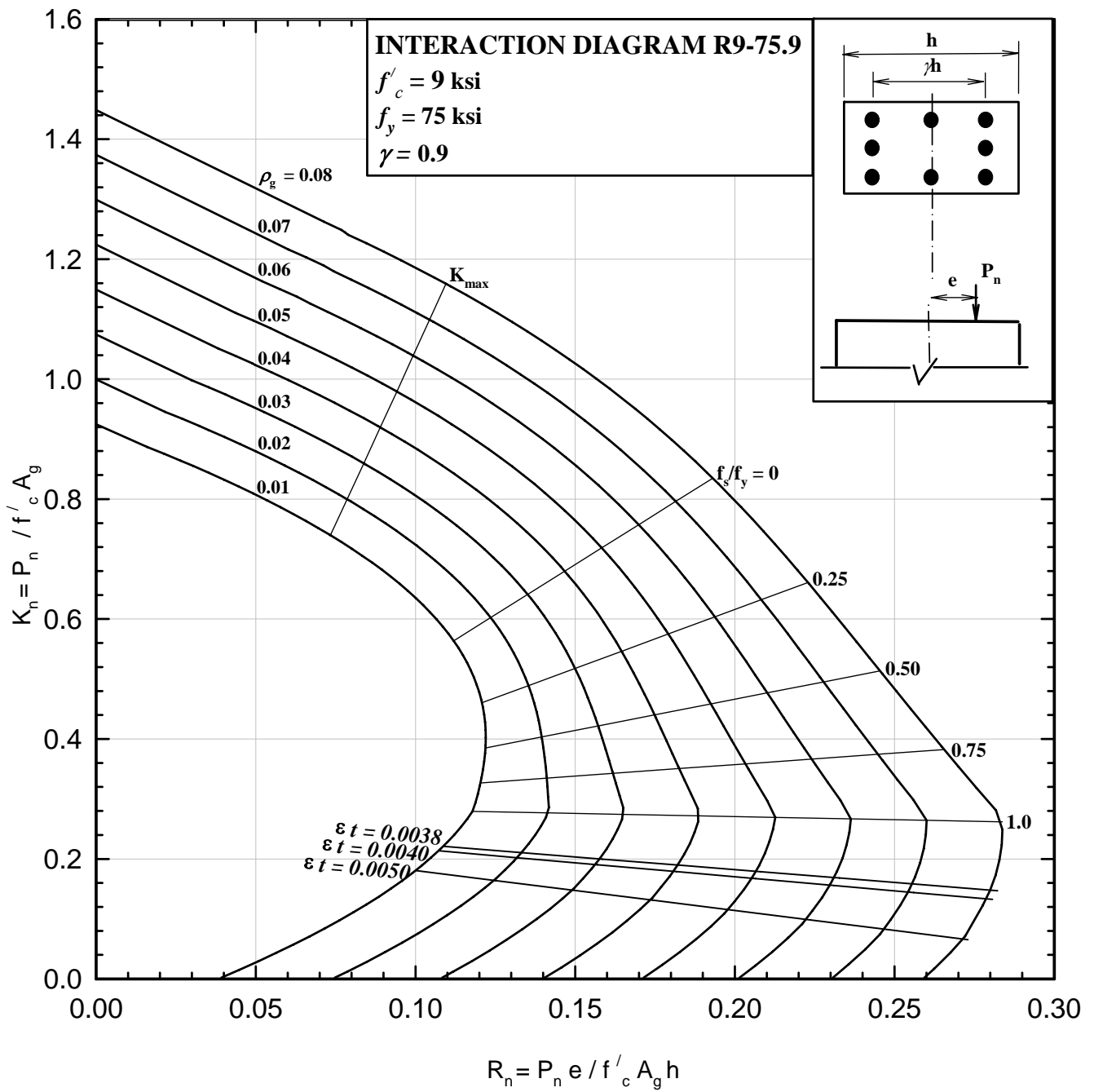

COLUMNS 3.6.1 - Nominal load-moment strength interaction diagram, R12-75.6

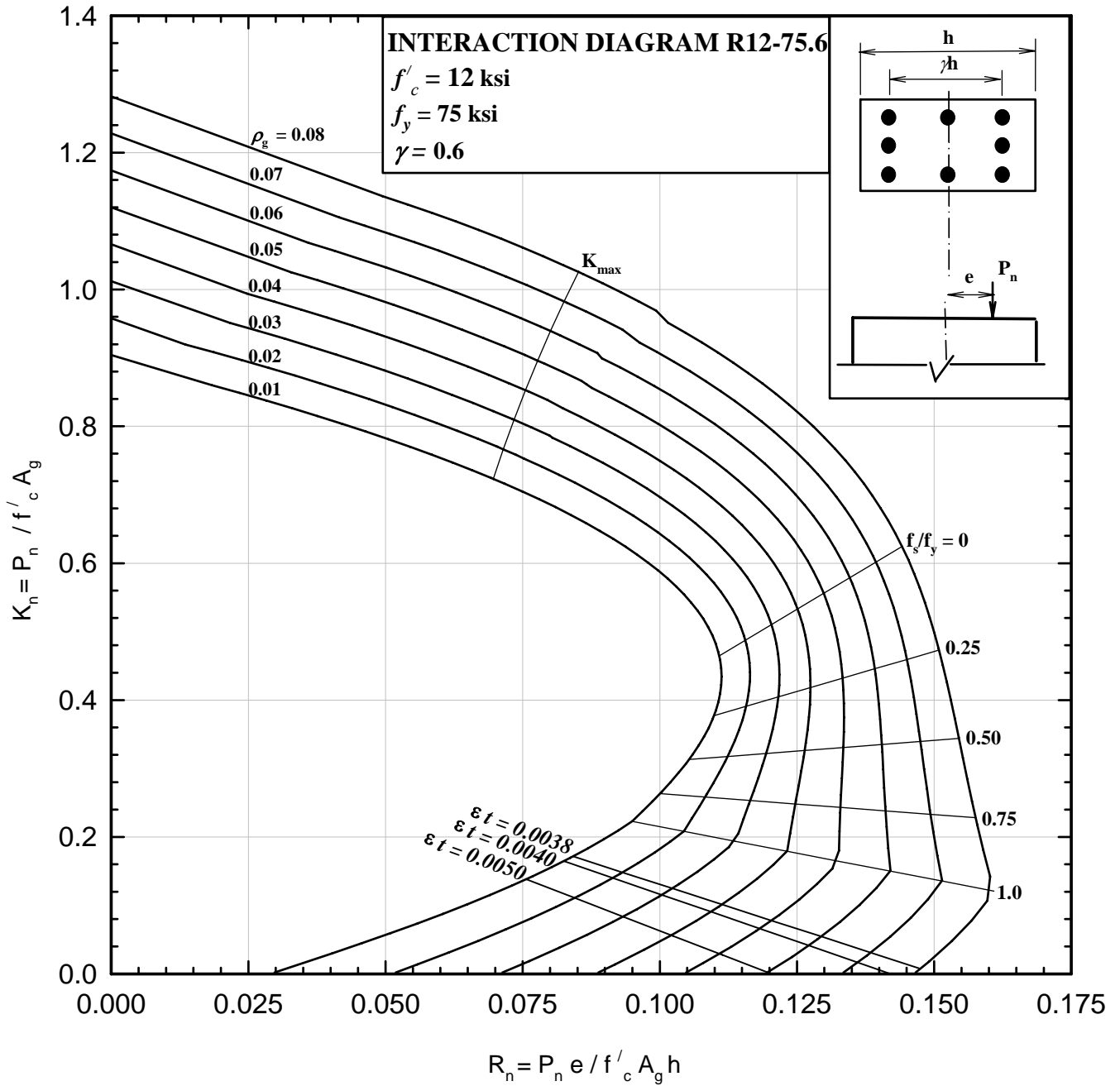

COLUMNS 3.6.2 - Nominal load-moment strength interaction diagram, R12-75.7

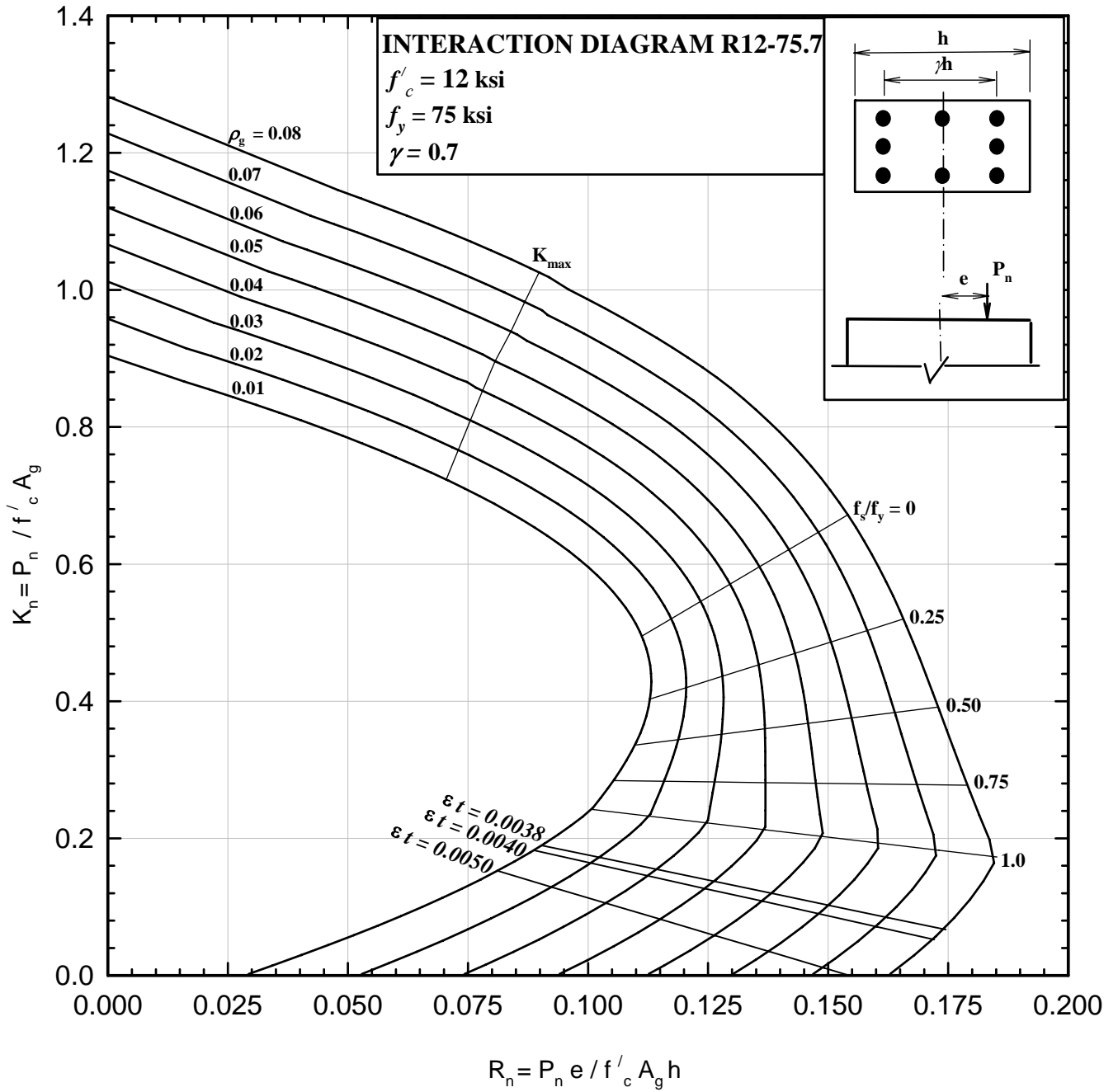

COLUMNS 3.6.3 - Nominal load-moment strength interaction diagram, R12-75.8

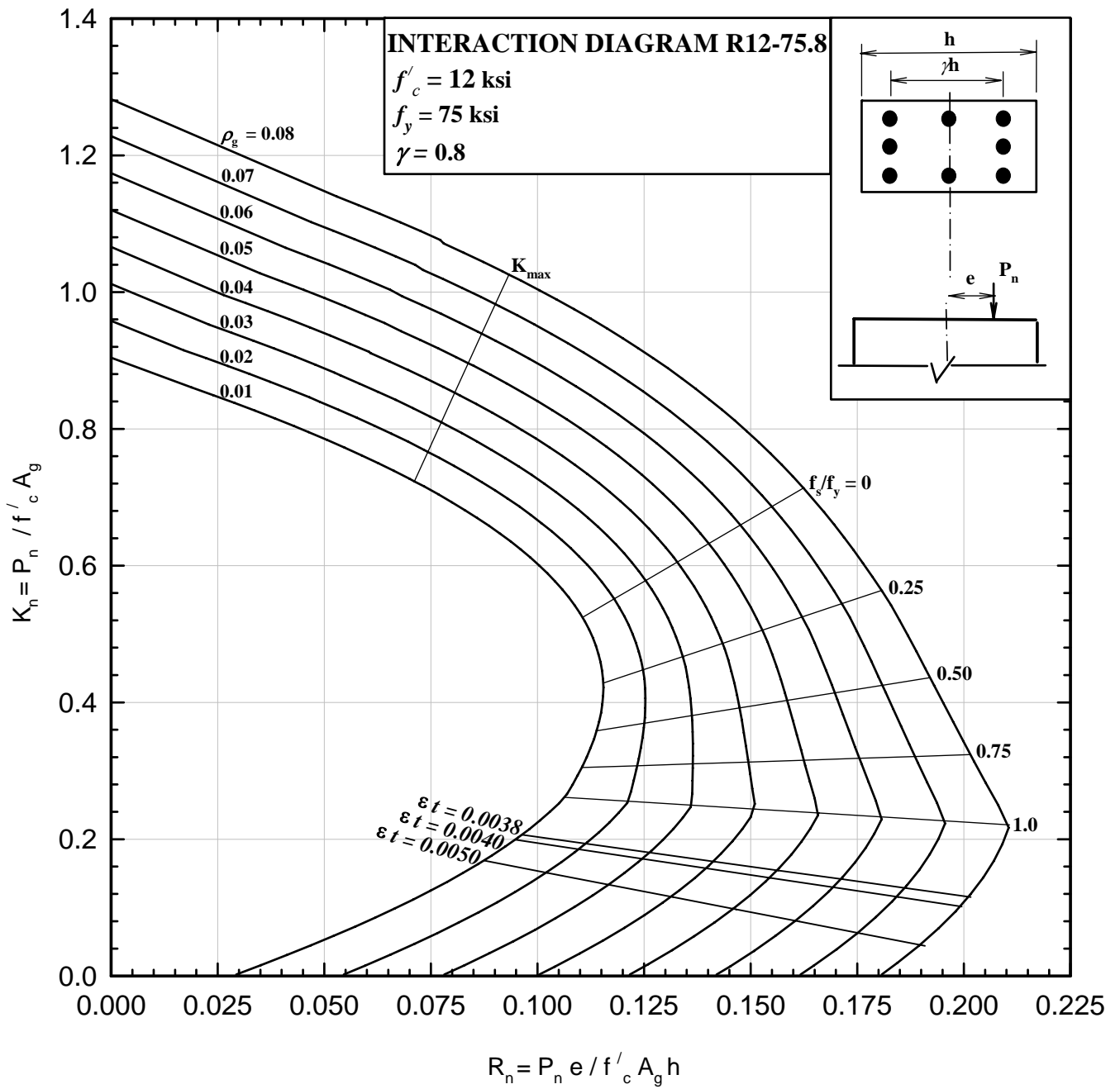

COLUMNS 3.6.4 - Nominal load-moment strength interaction diagram, R12-75.9

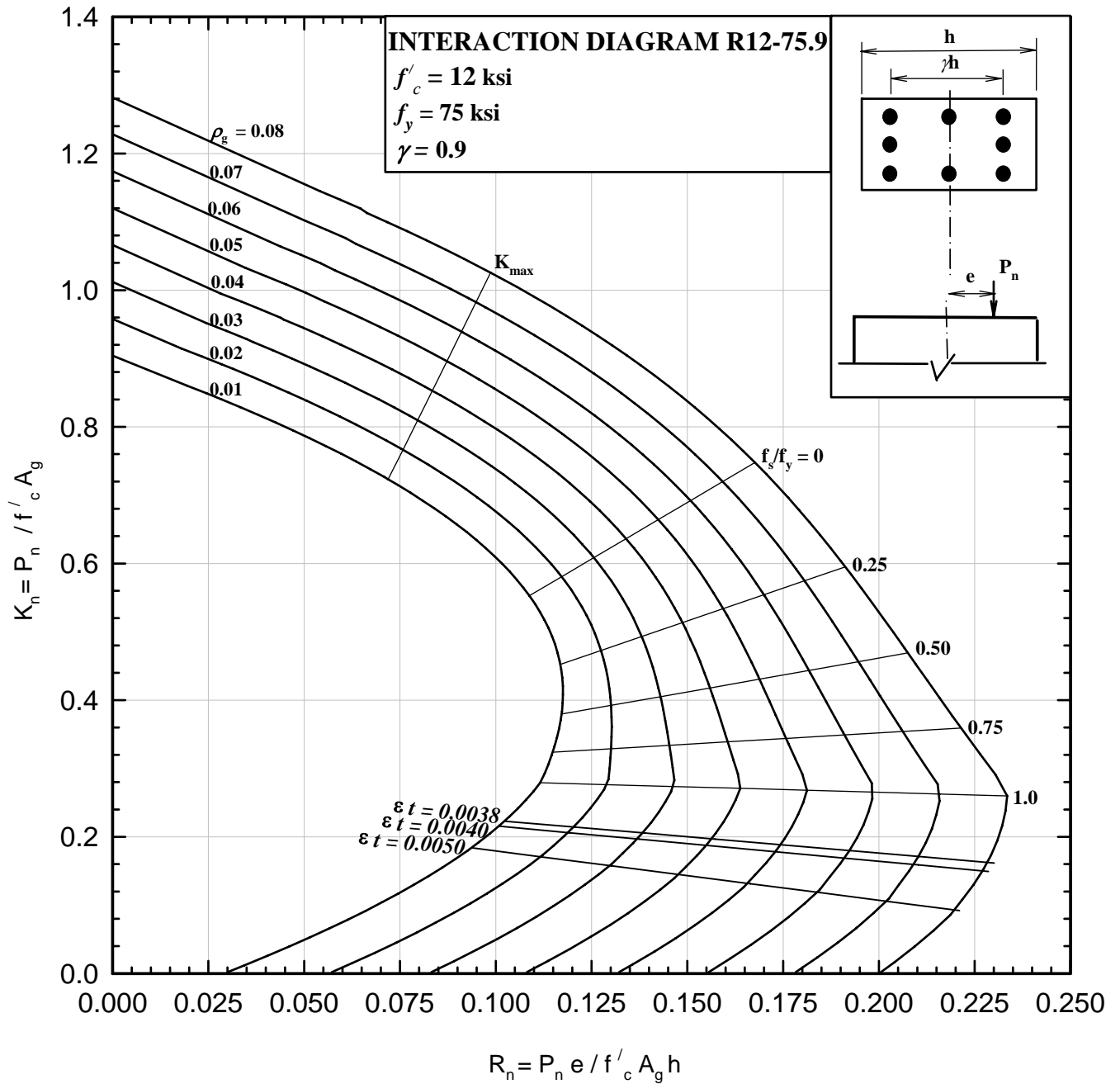

COLUMNS 3.7.1 - Nominal load-moment strength interaction diagram, L3-60.6

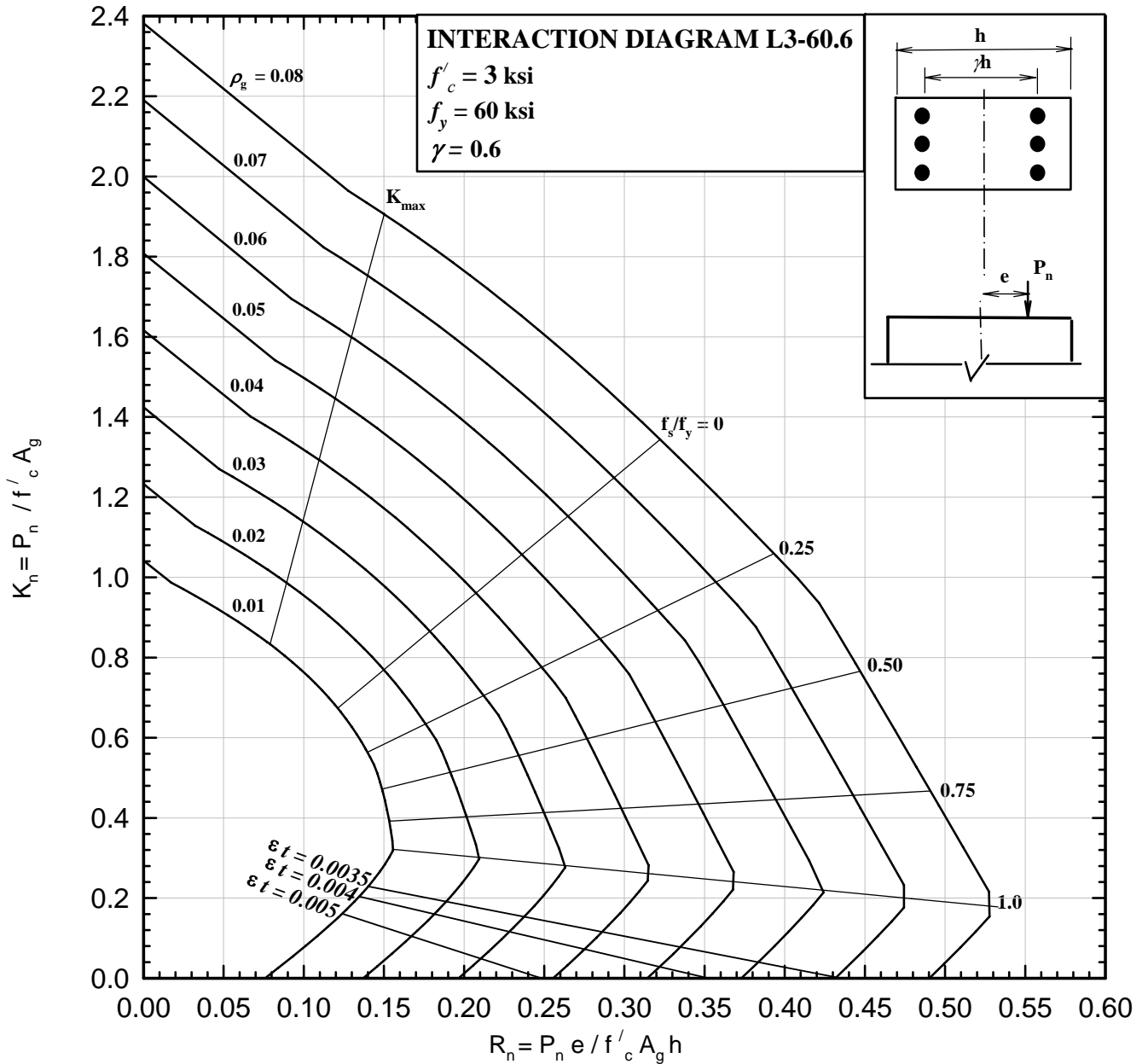

COLUMNS 3.7.2 - Nominal load-moment strength interaction diagram, L3-60.7

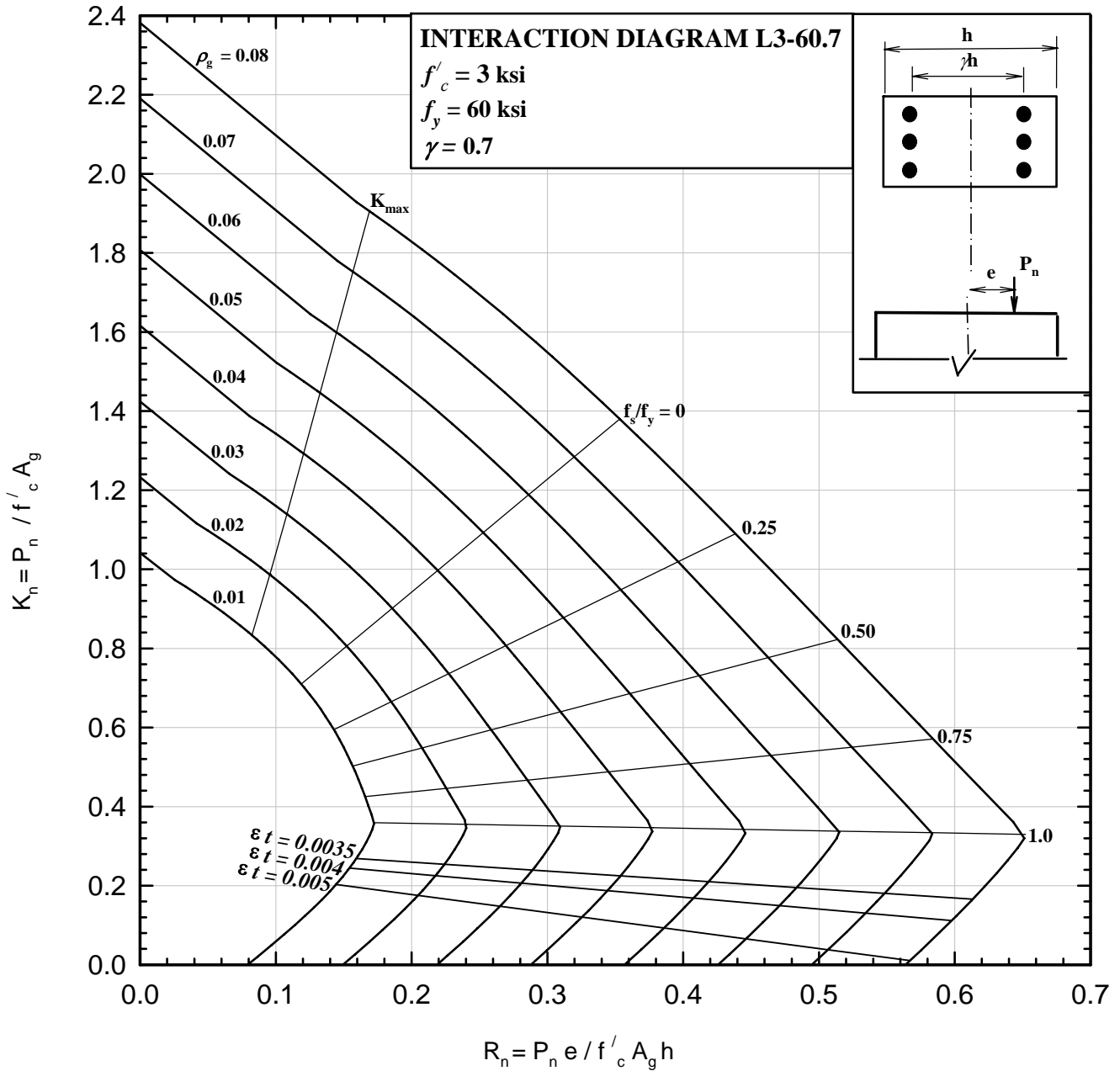

COLUMNS 3.7.3 - Nominal load-moment strength interaction diagram, L3-60.8

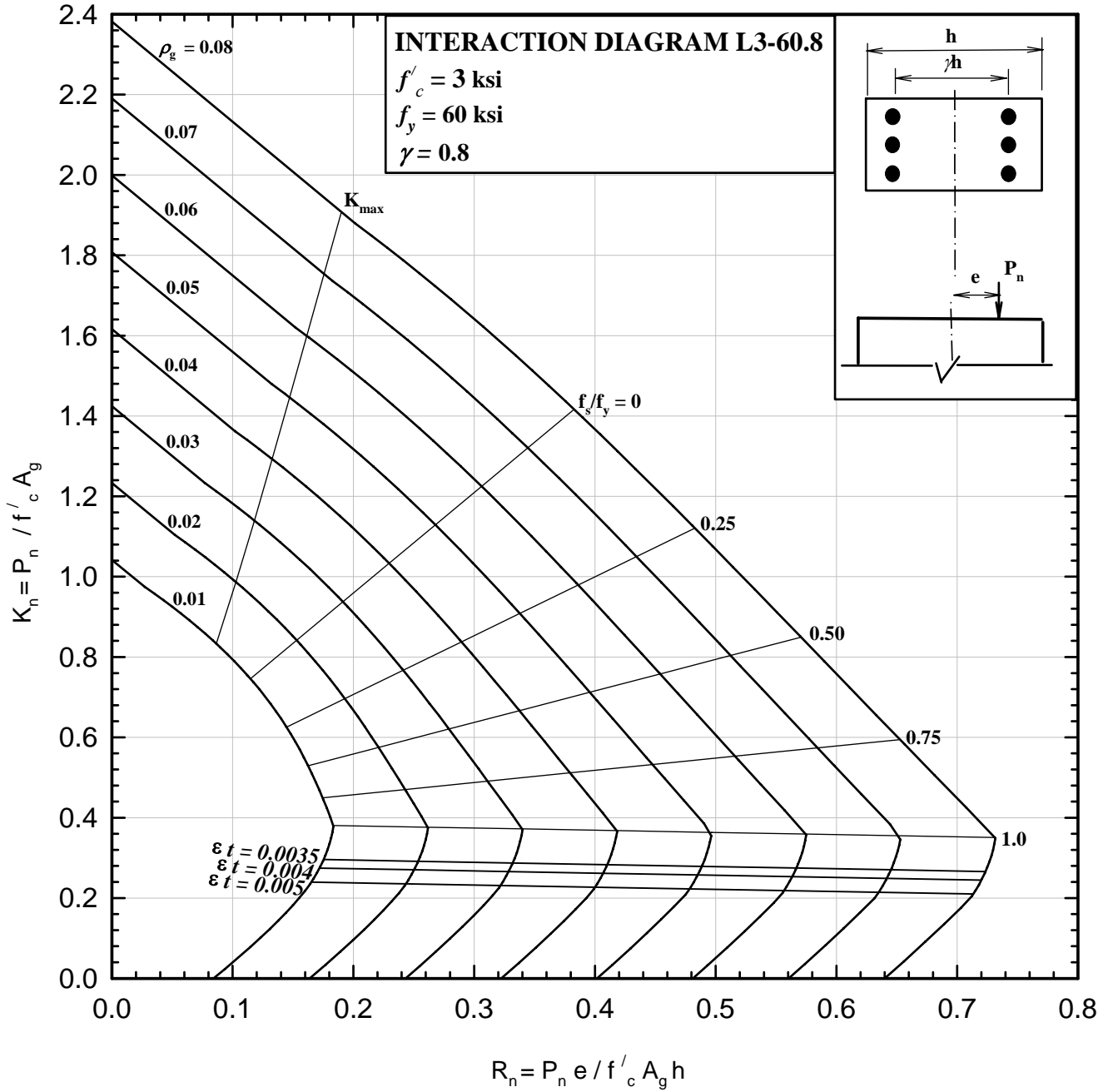

COLUMNS 3.7.4 - Nominal load-moment strength interaction diagram, L3-60.9

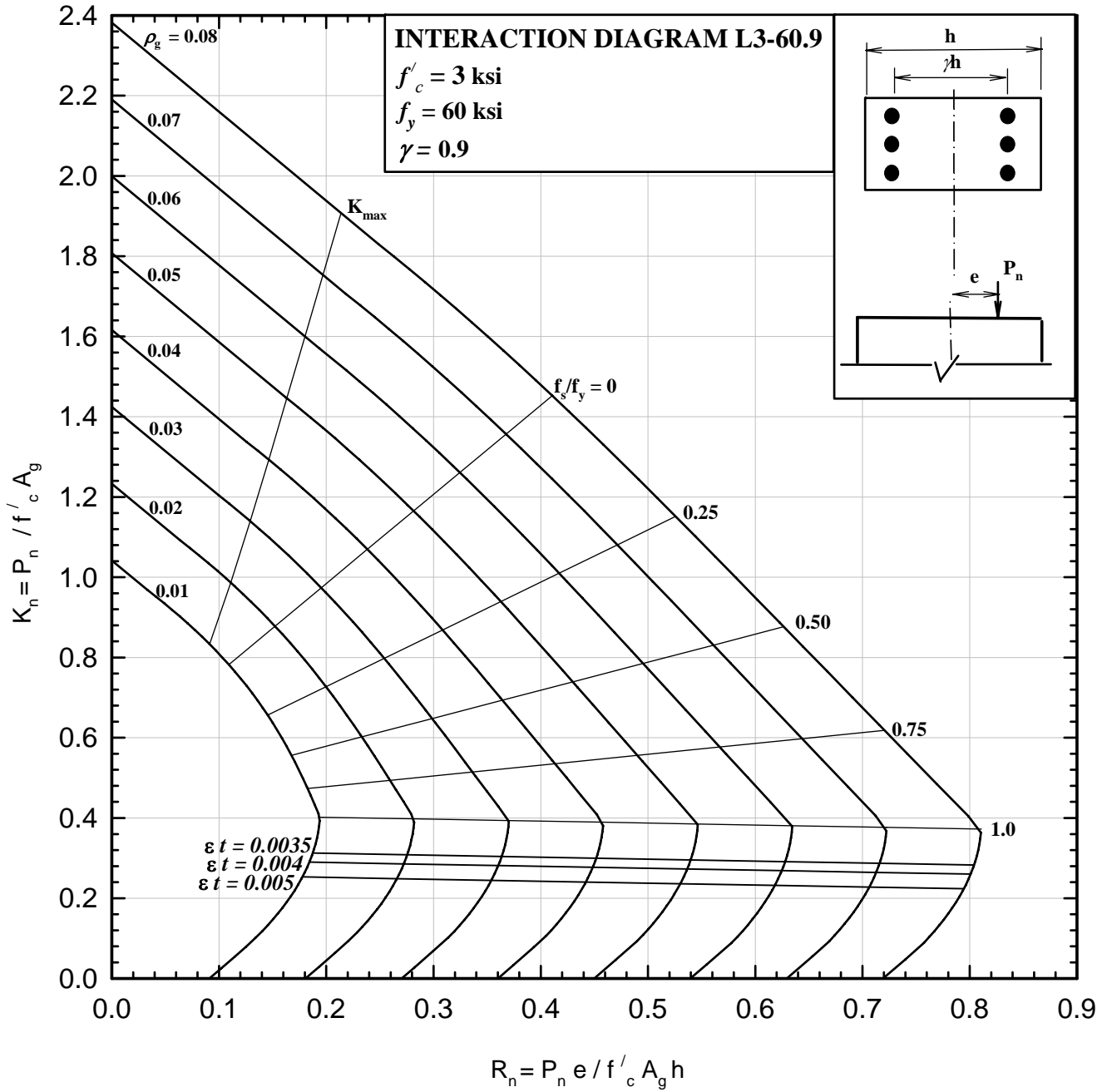

COLUMNS 3.8.1 - Nominal load-moment strength interaction diagram, L4-60.6

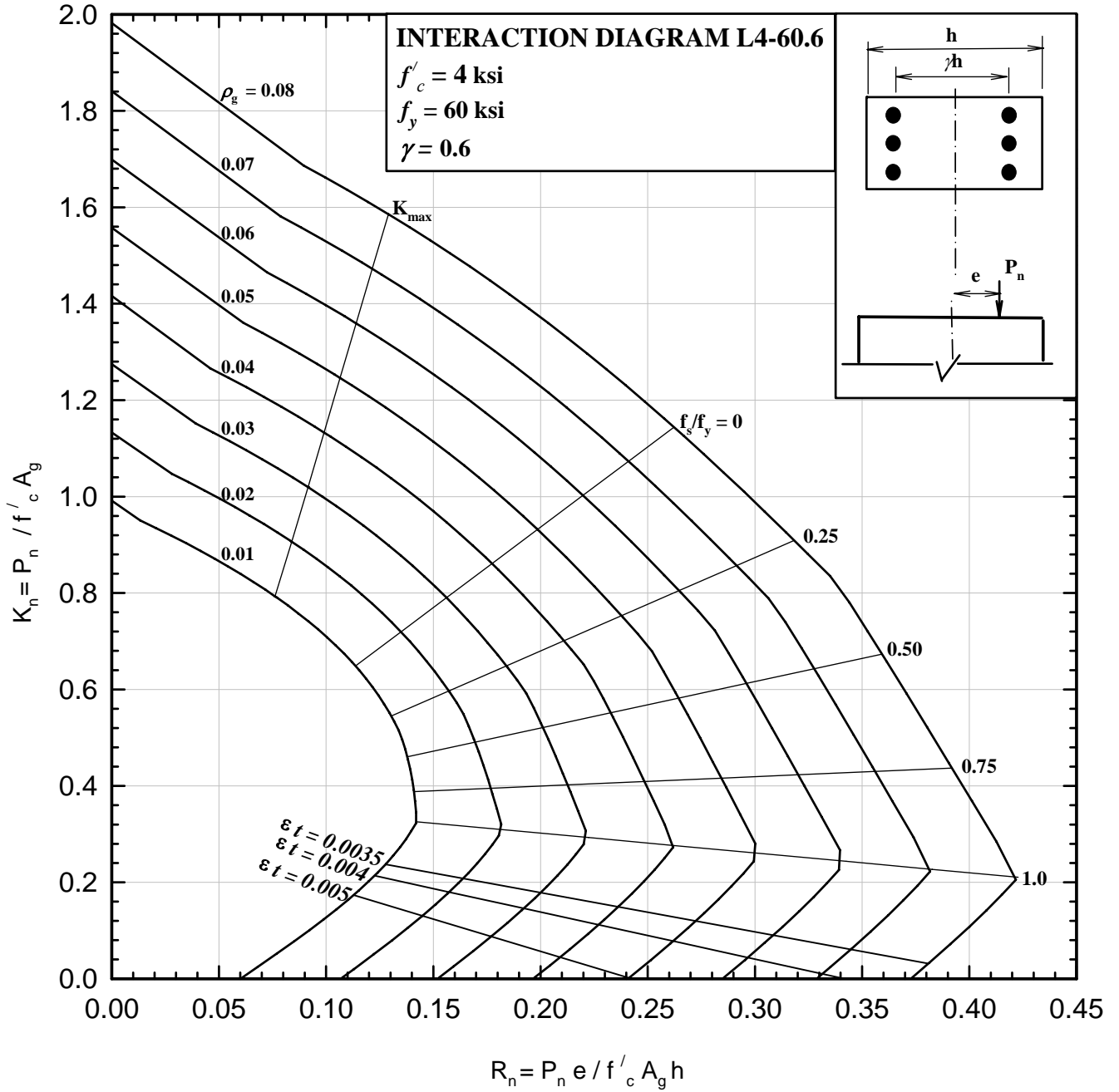

COLUMNS 3.8.2 - Nominal load-moment strength interaction diagram, L4-60.7

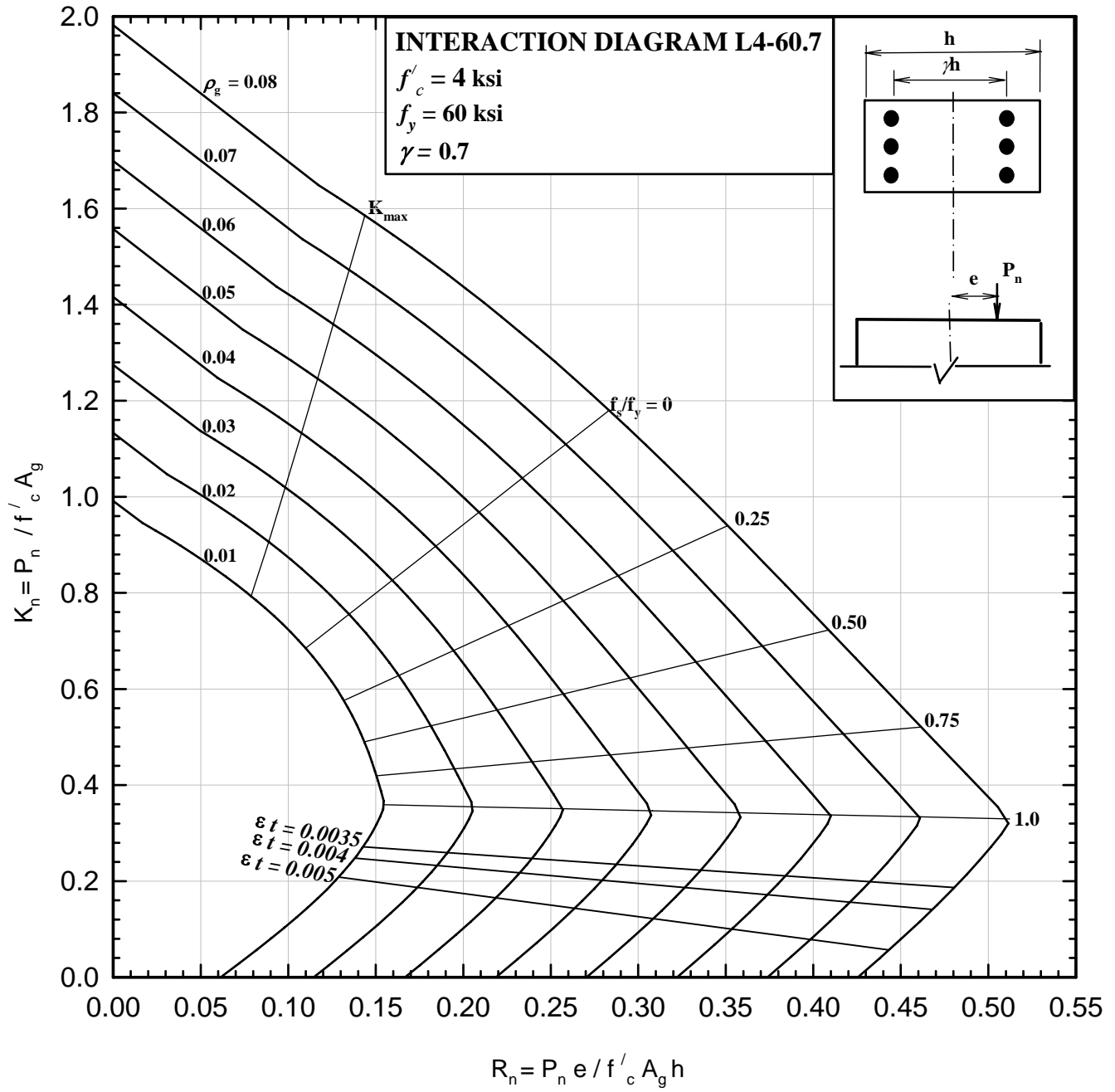

COLUMNS 3.8.3 - Nominal load-moment strength interaction diagram, L4-60.8

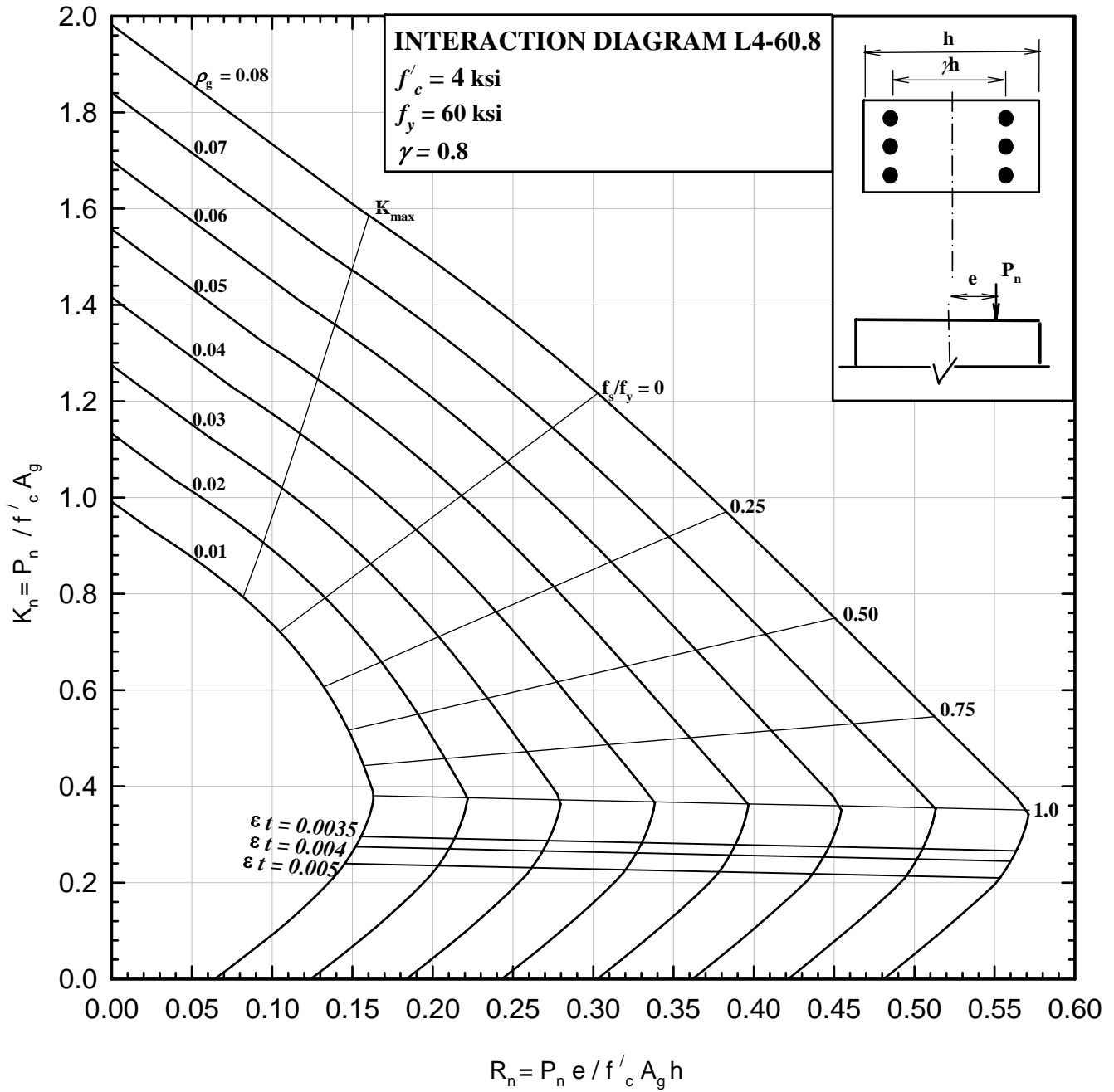

COLUMNS 3.8.4 - Nominal load-moment strength interaction diagram, L4-60.9

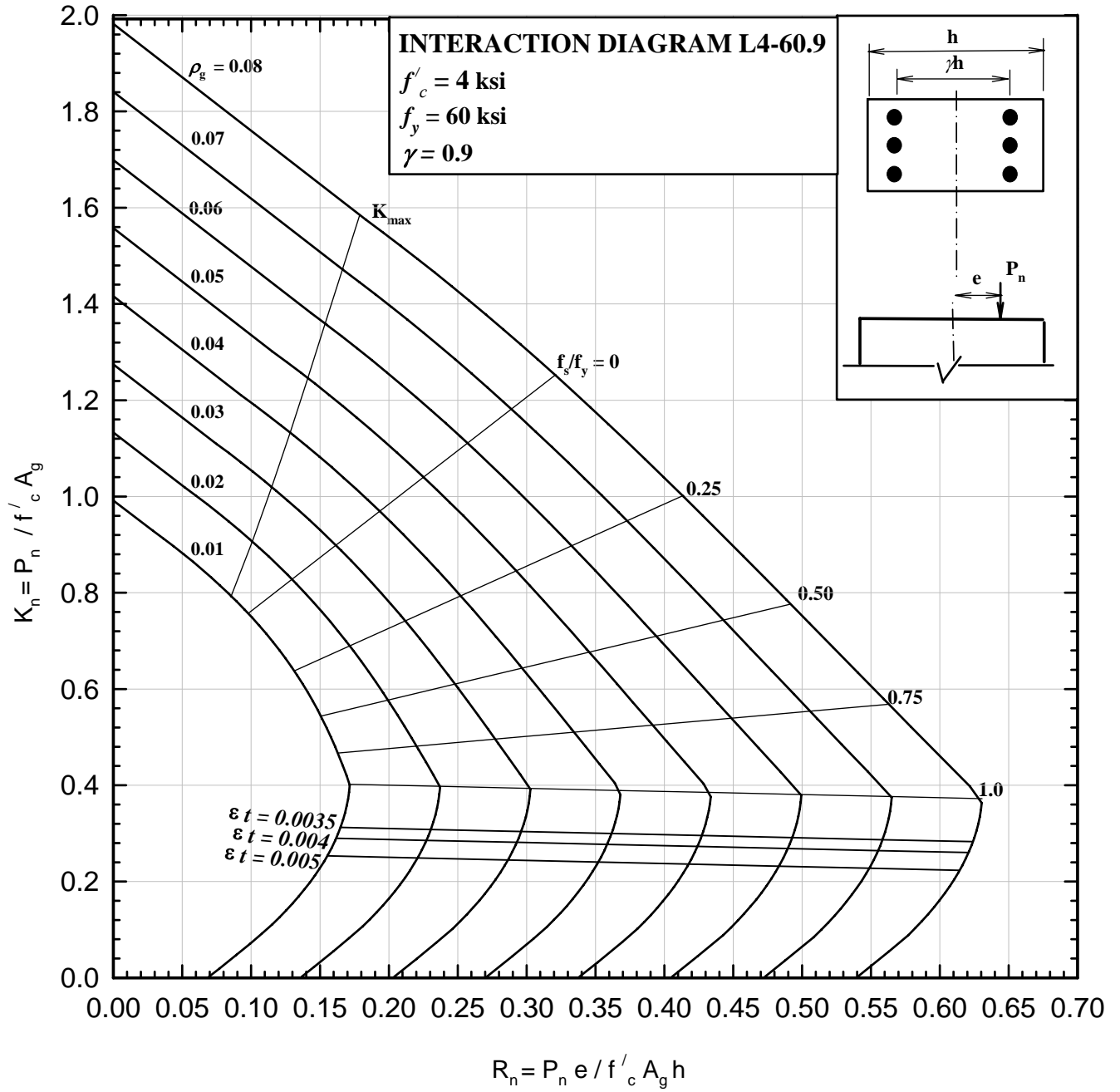

COLUMNS 3.9.1 - Nominal load-moment strength interaction diagram, L5-60.6

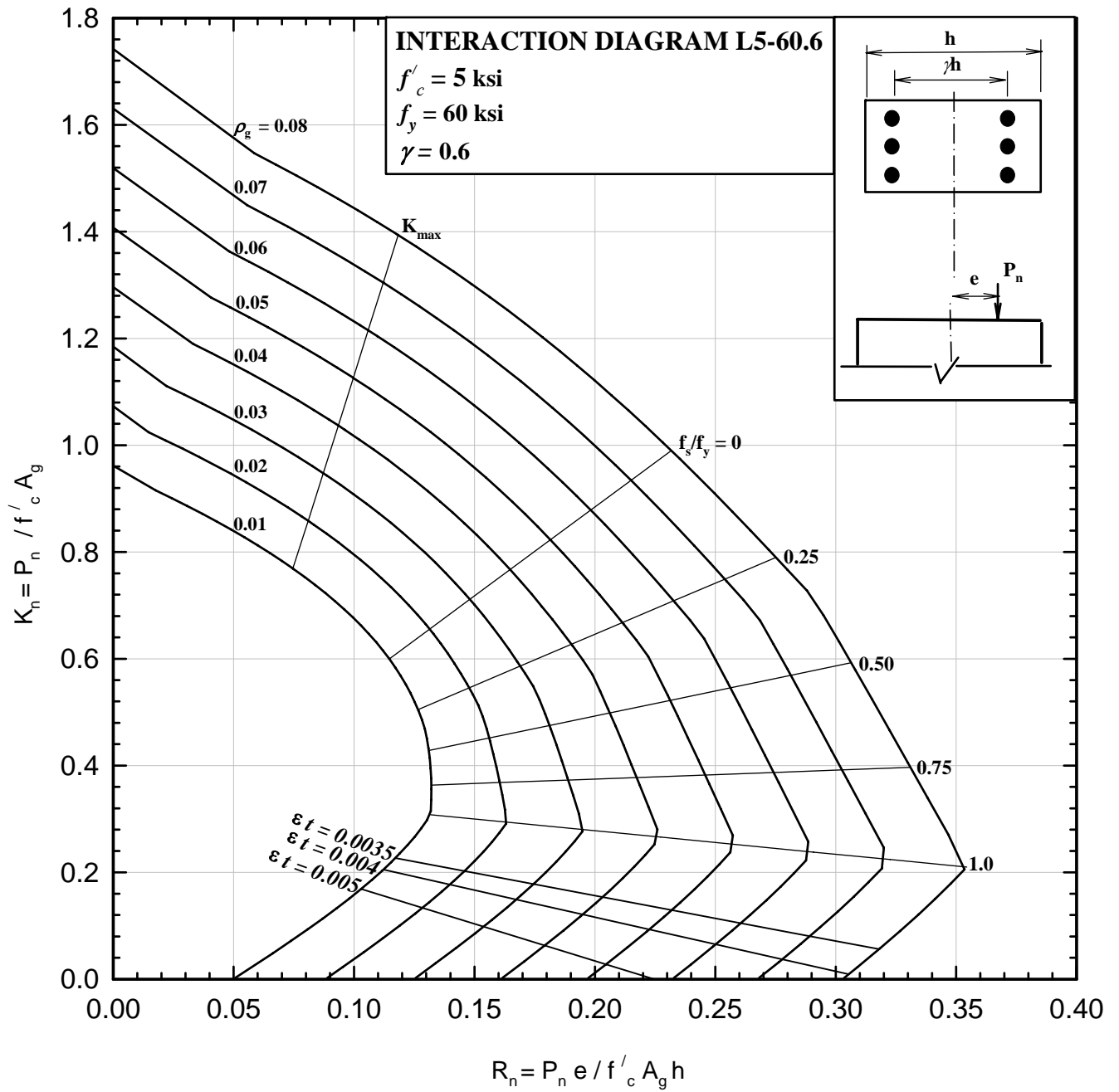

COLUMNS 3.9.2 - Nominal load-moment strength interaction diagram, L5-60.7

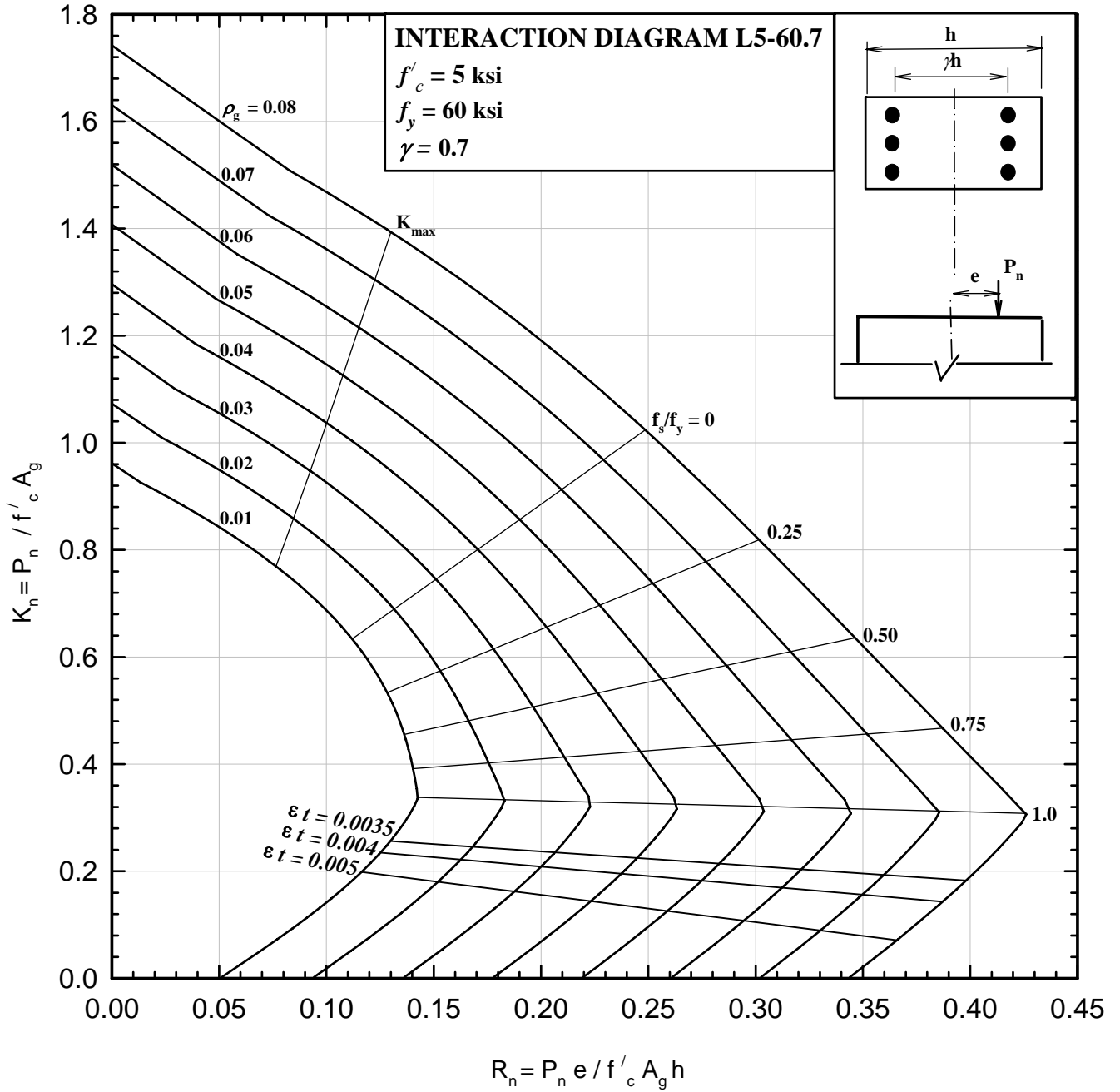

COLUMNS 3.9.3 - Nominal load-moment strength interaction diagram, L5-60.8

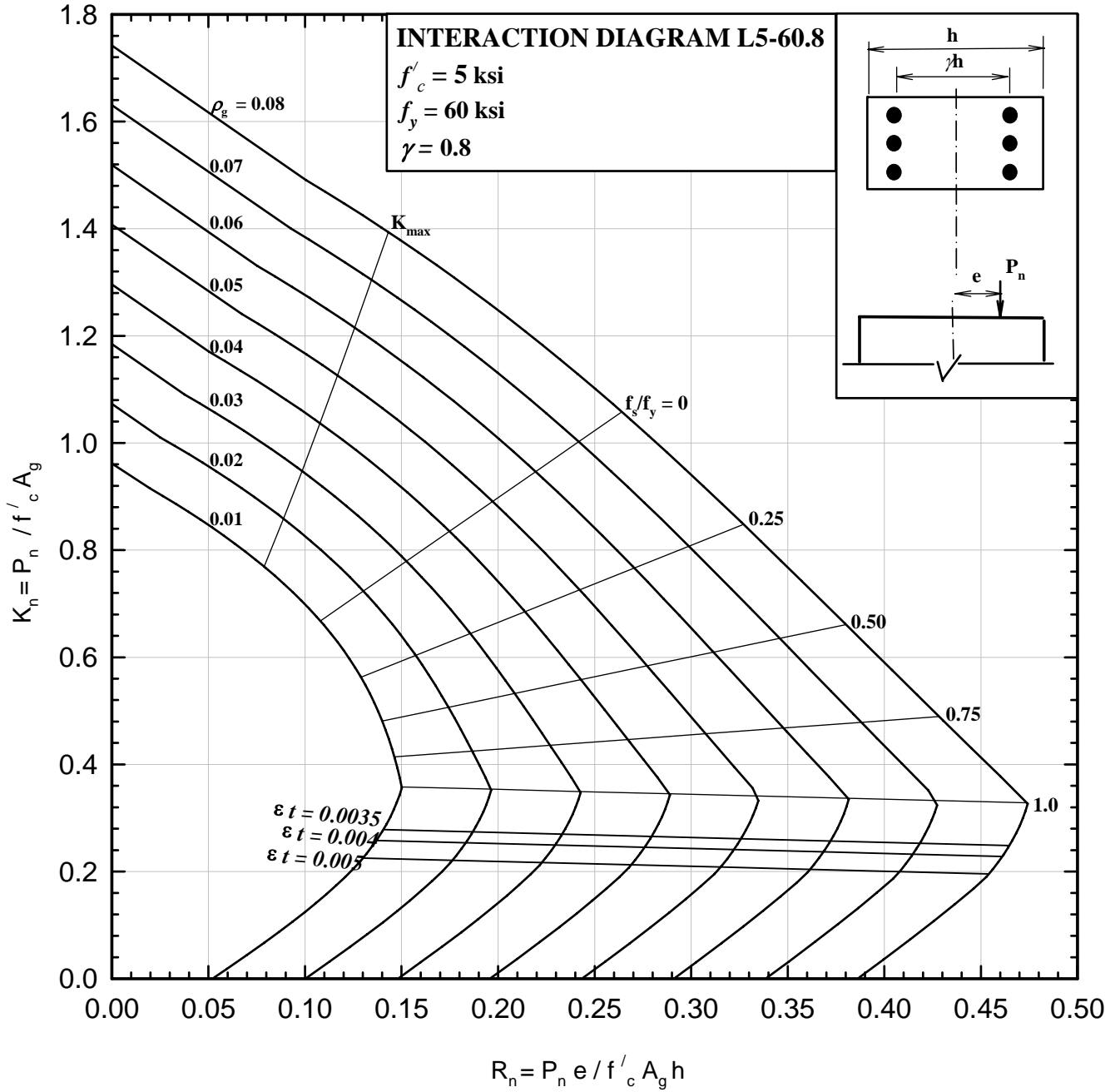

COLUMNS 3.9.4 - Nominal load-moment strength interaction diagram, L5-60.9

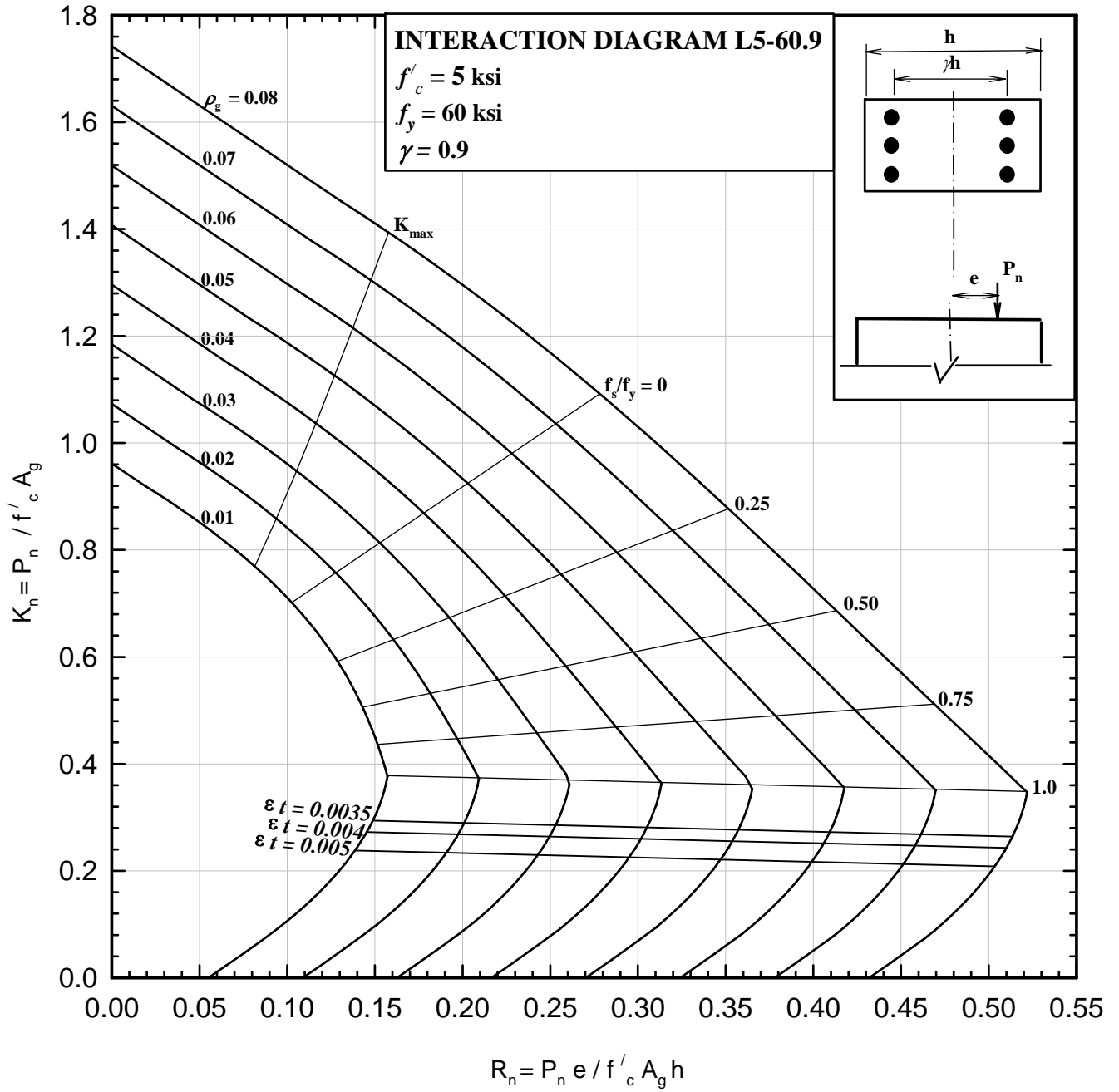

COLUMNS 3.10.1 - Nominal load-moment strength interaction diagram, L6-60.6

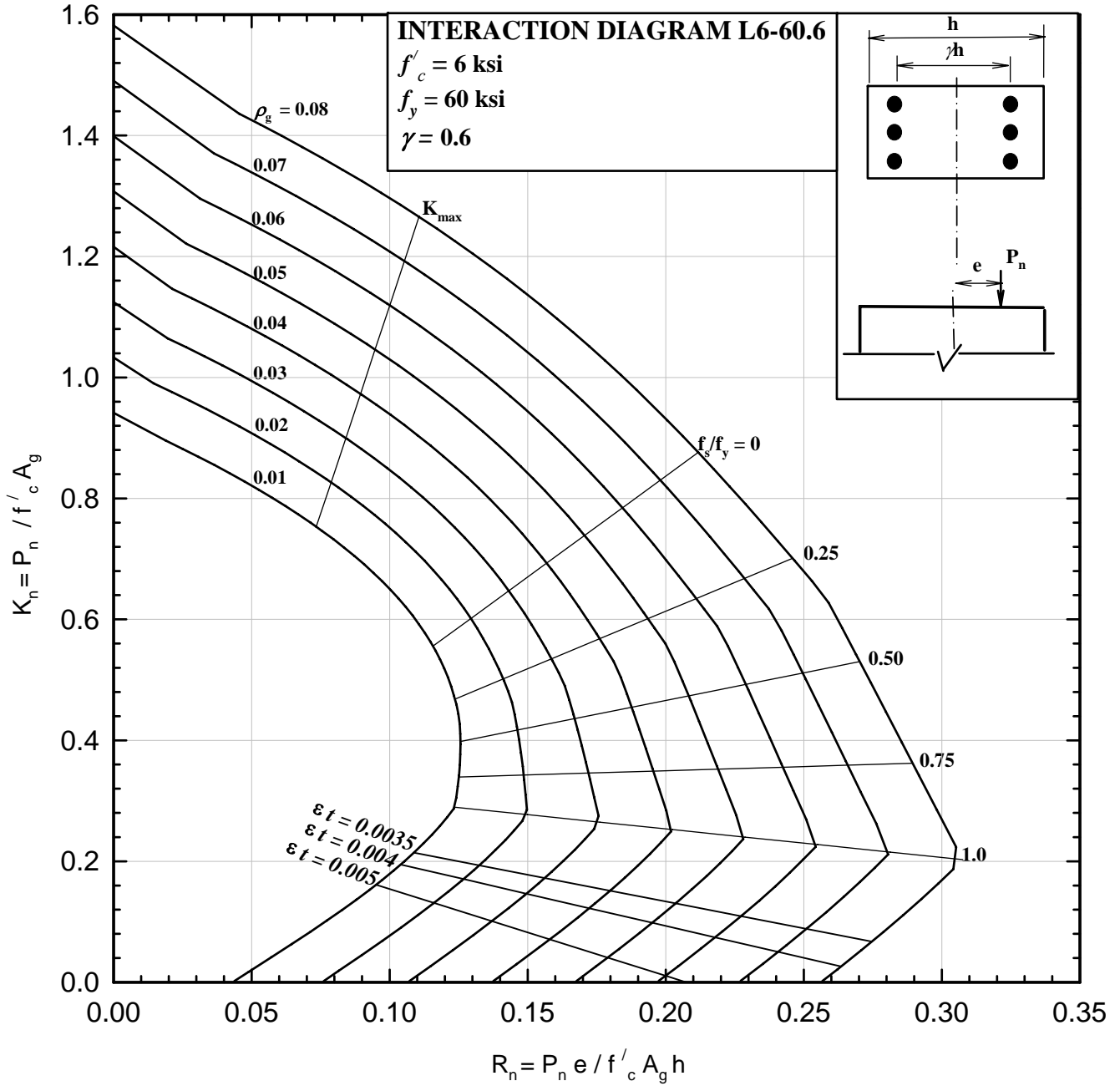

COLUMNS 3.10.2 - Nominal load-moment strength interaction diagram, L6-60.7

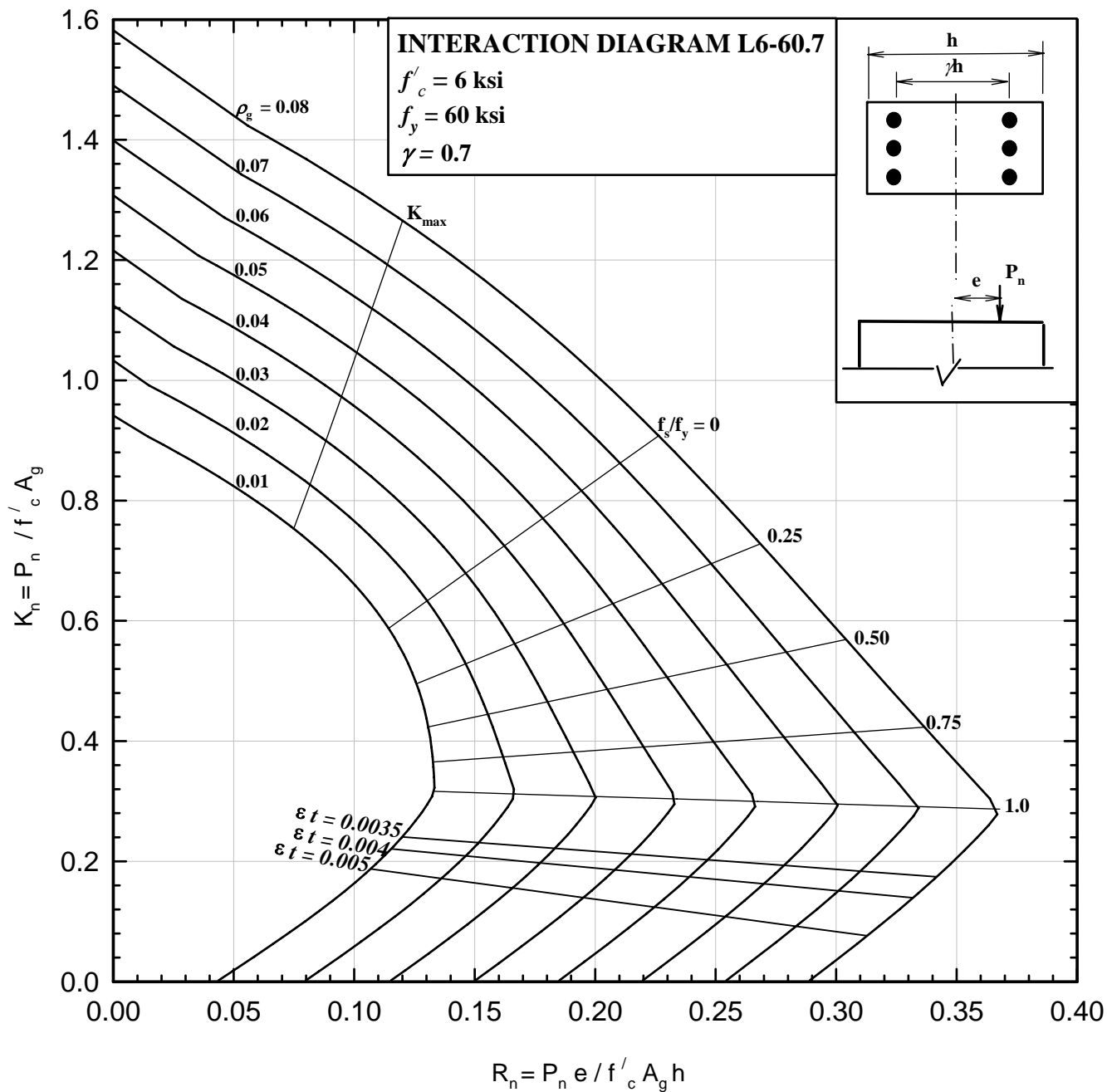

COLUMNS 3.10.3 - Nominal load-moment strength interaction diagram, L6-60.8

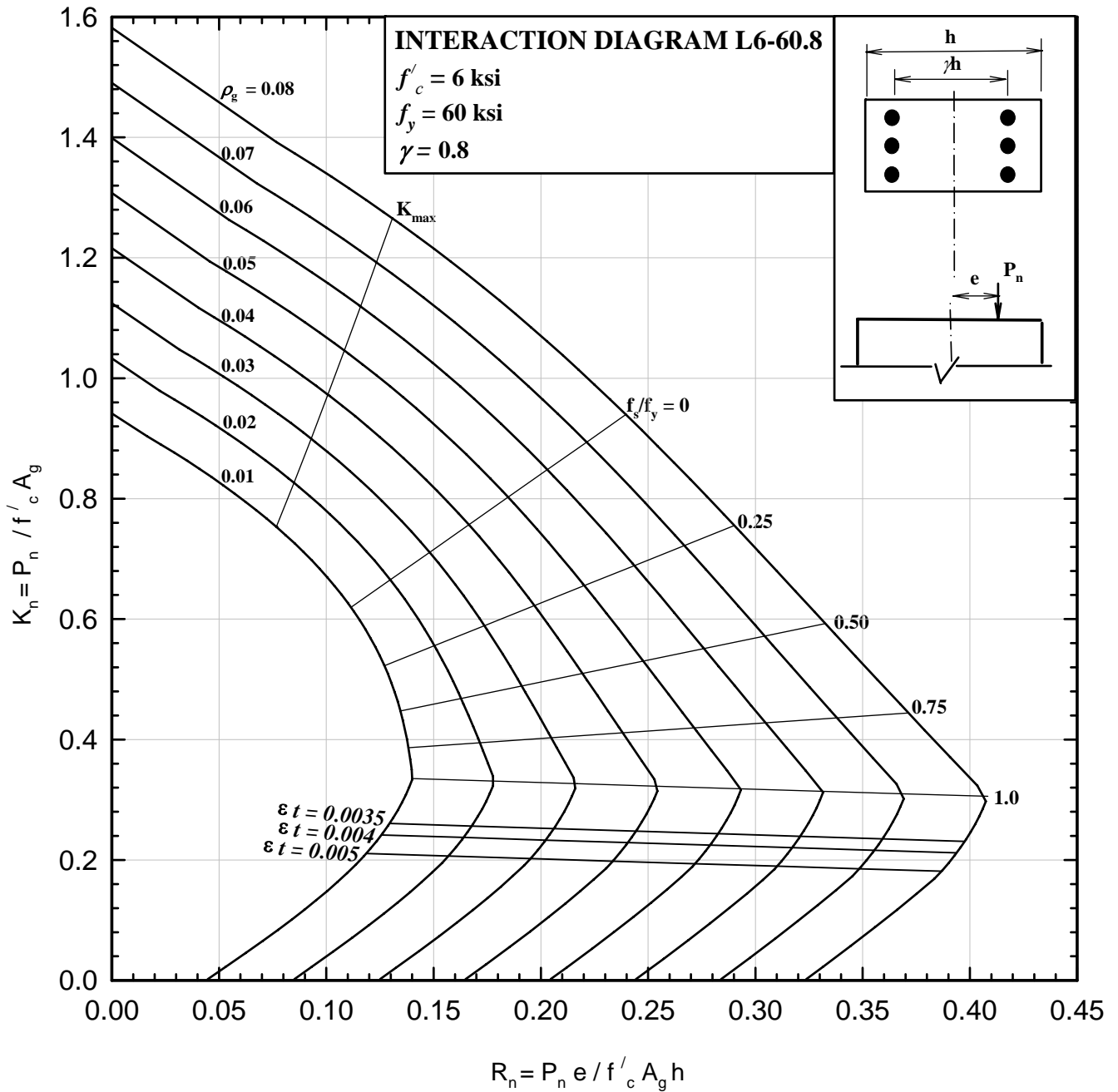

COLUMNS 3.10.4 - Nominal load-moment strength interaction diagram, L6-60.9

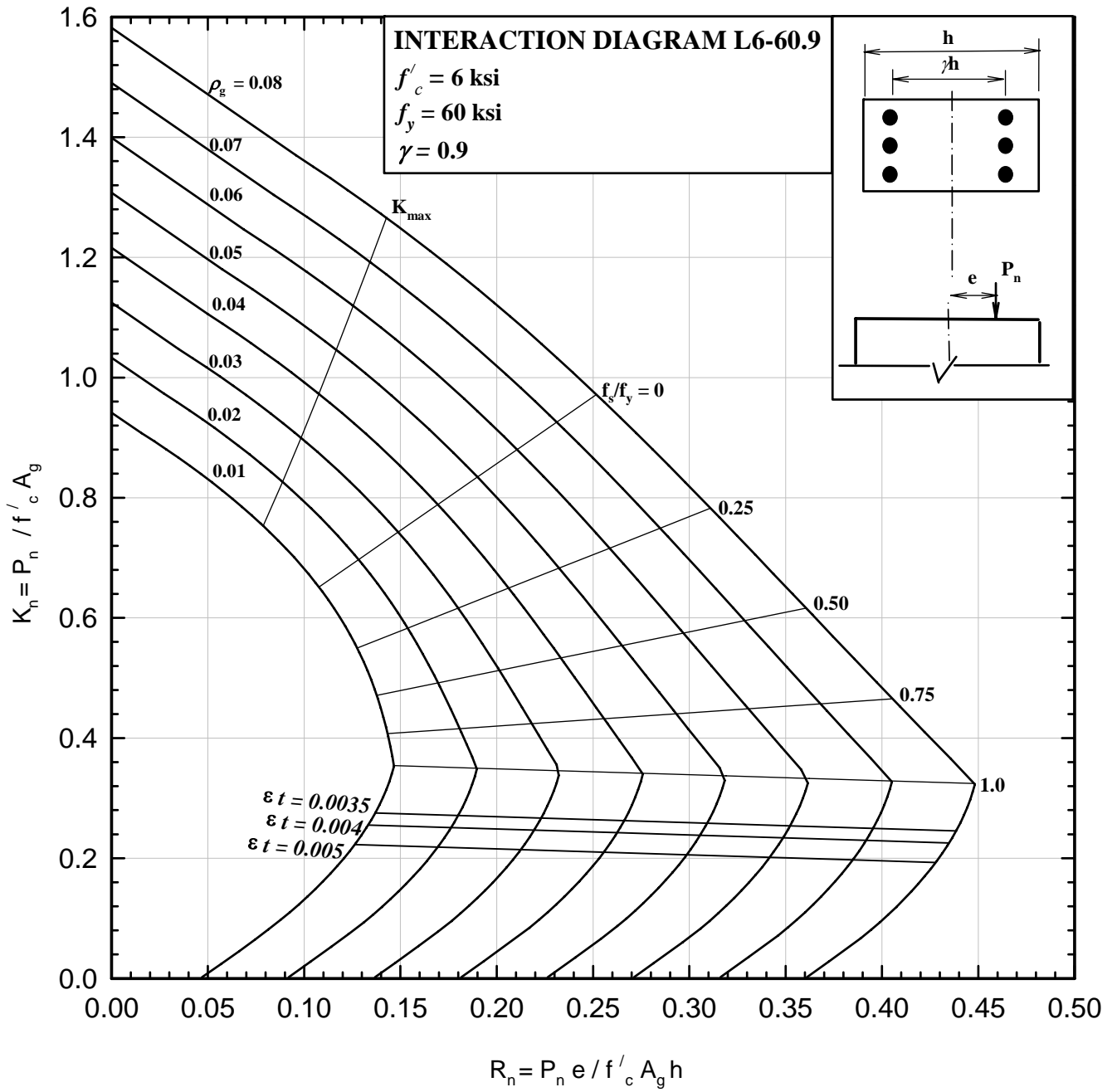

COLUMNS 3.11.1 - Nominal load-moment strength interaction diagram, L9-75.6

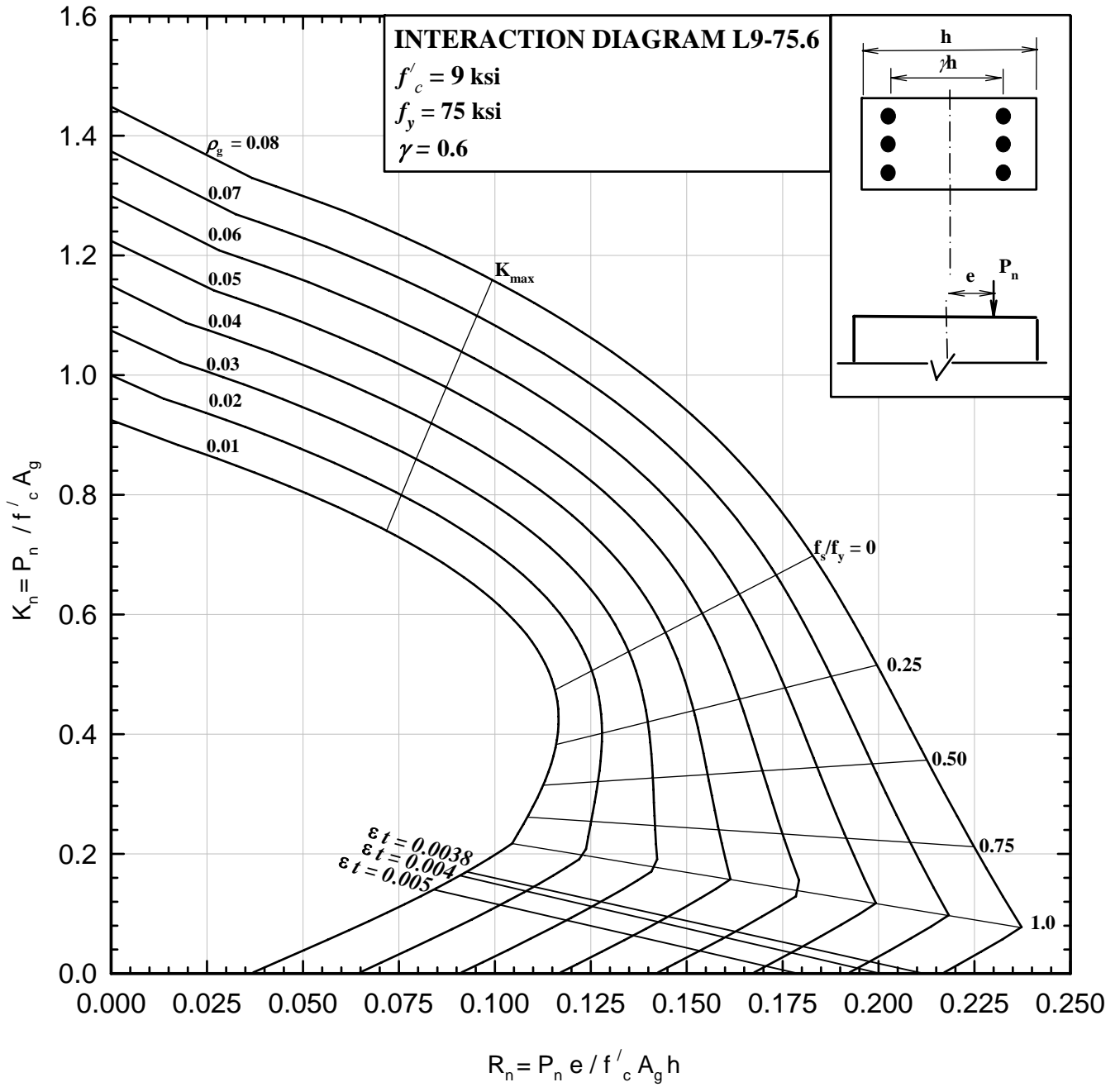

COLUMNS 3.11.2 - Nominal load-moment strength interaction diagram, L9-75.7

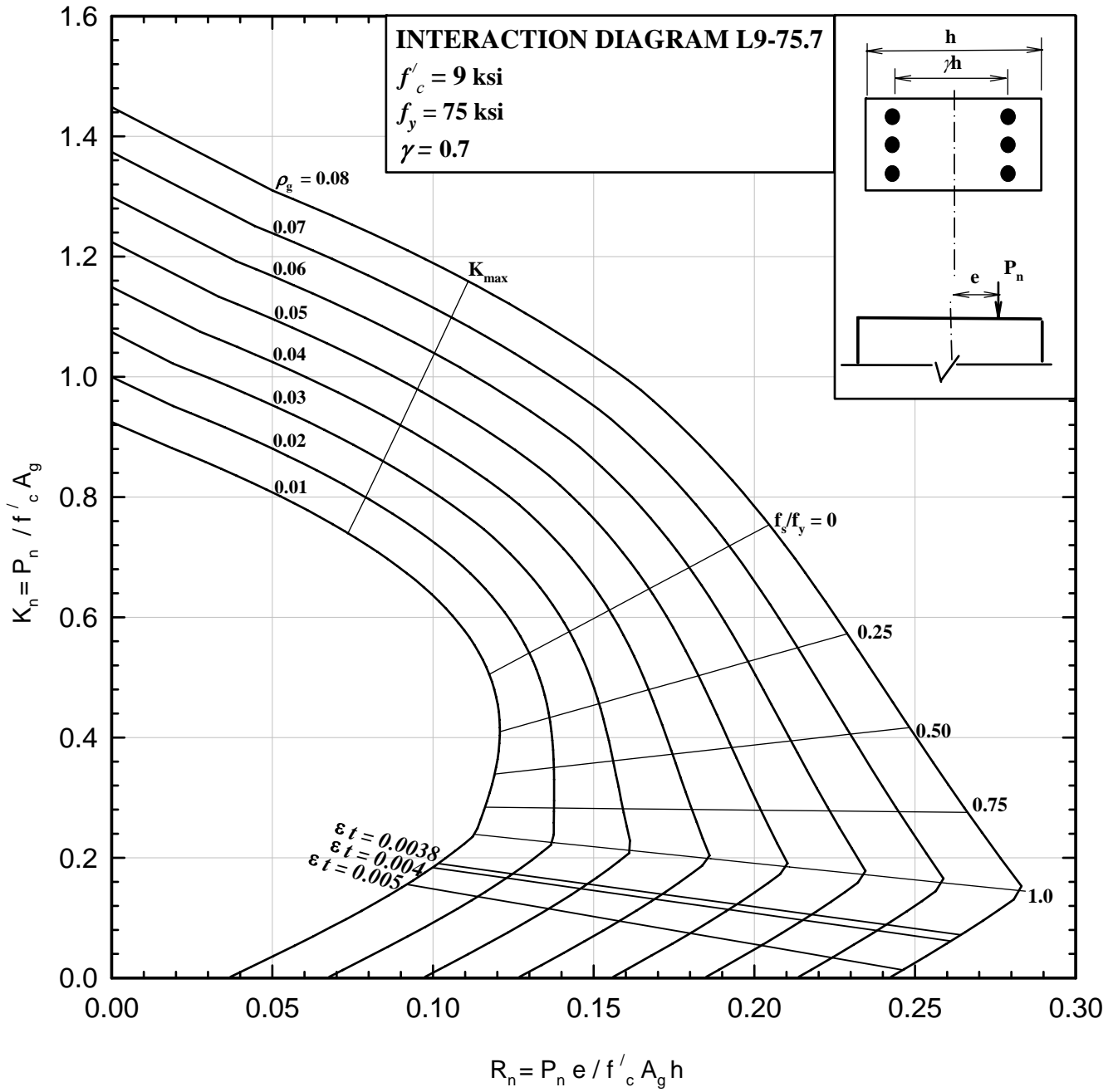

COLUMNS 3.11.3 - Nominal load-moment strength interaction diagram, L9-75.8

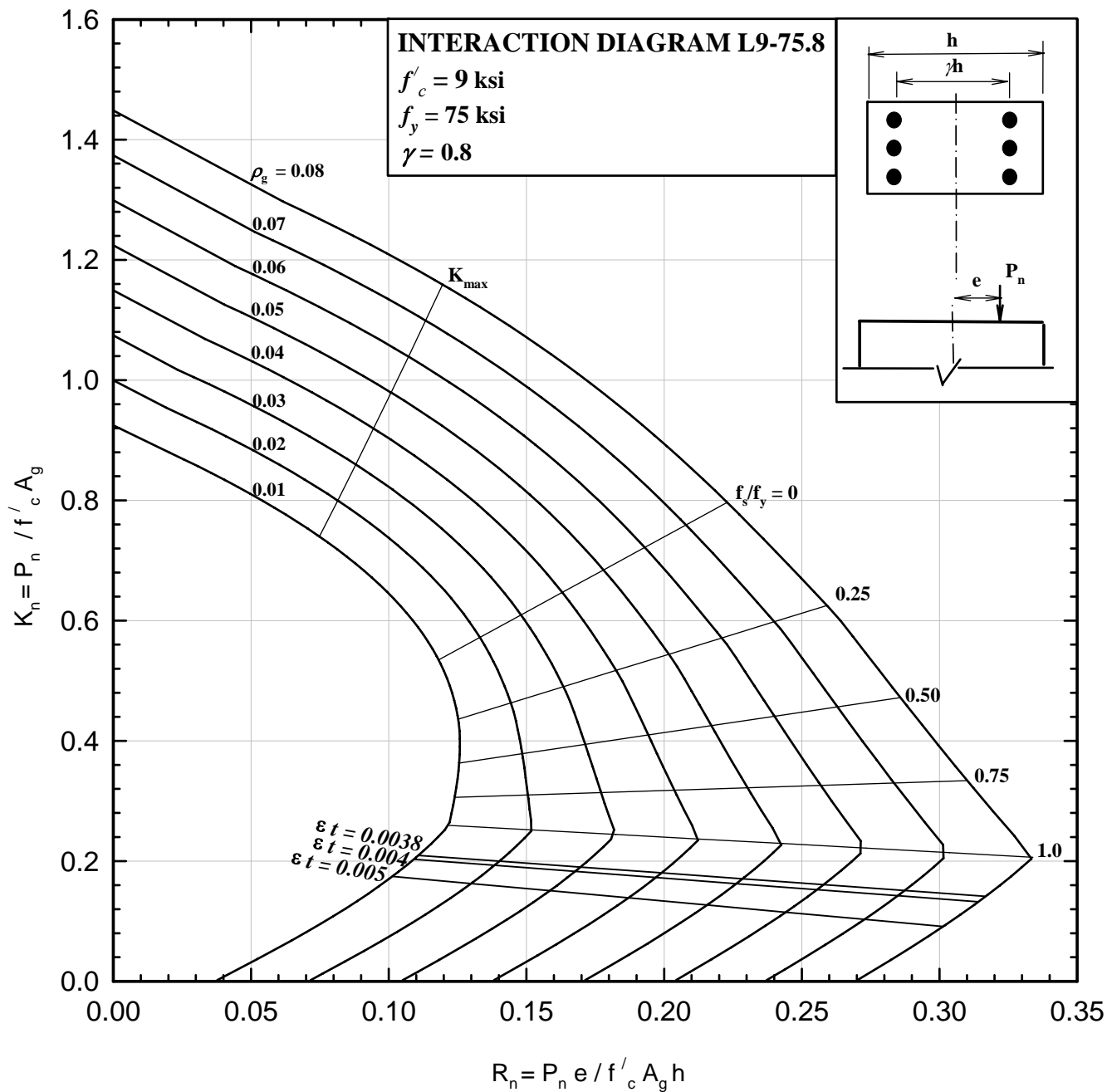

COLUMNS 3.11.4 - Nominal load-moment strength interaction diagram, L9-75.9

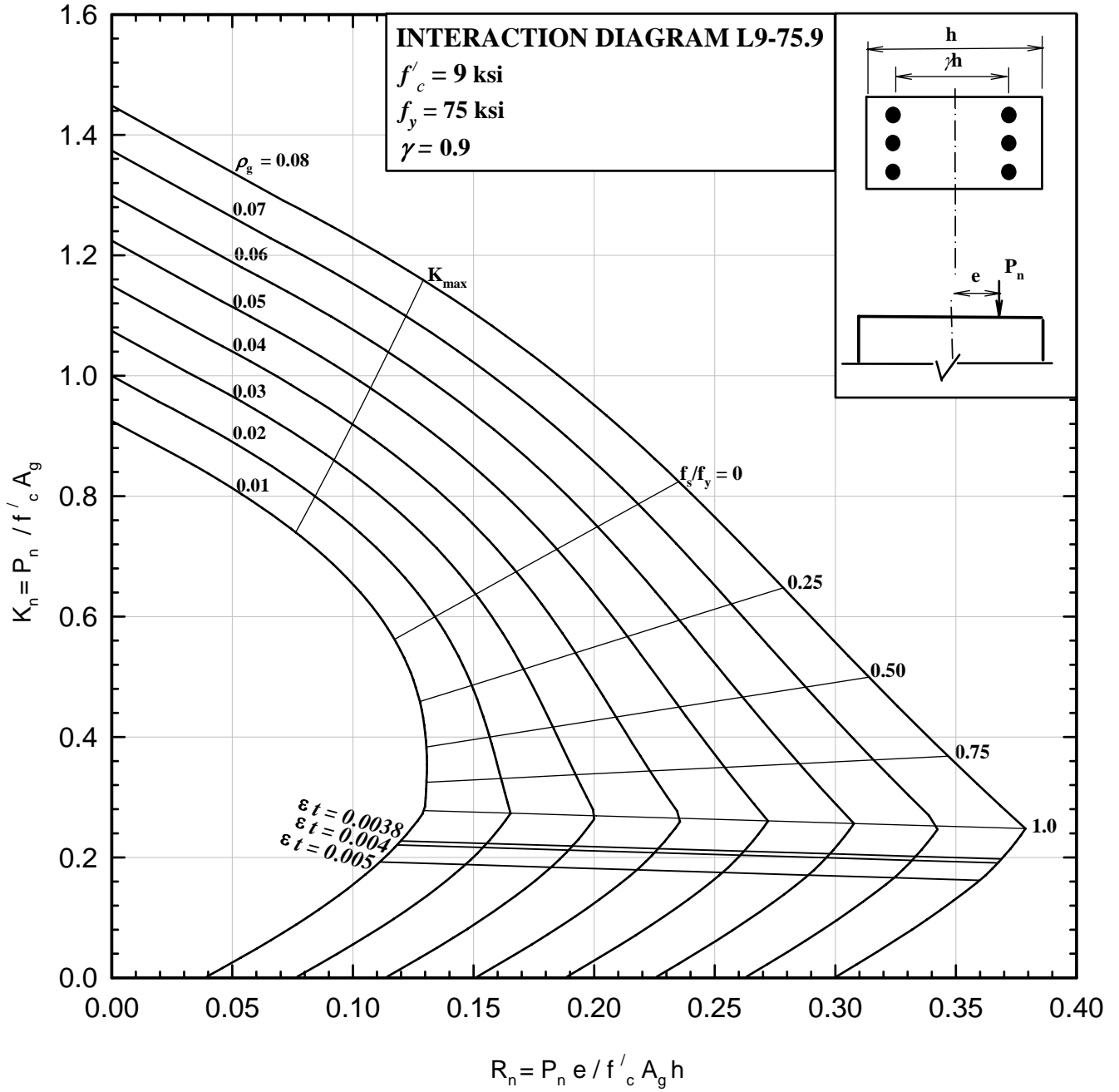

COLUMNS 3.12.1 - Nominal load-moment strength interaction diagram, L12-75.6

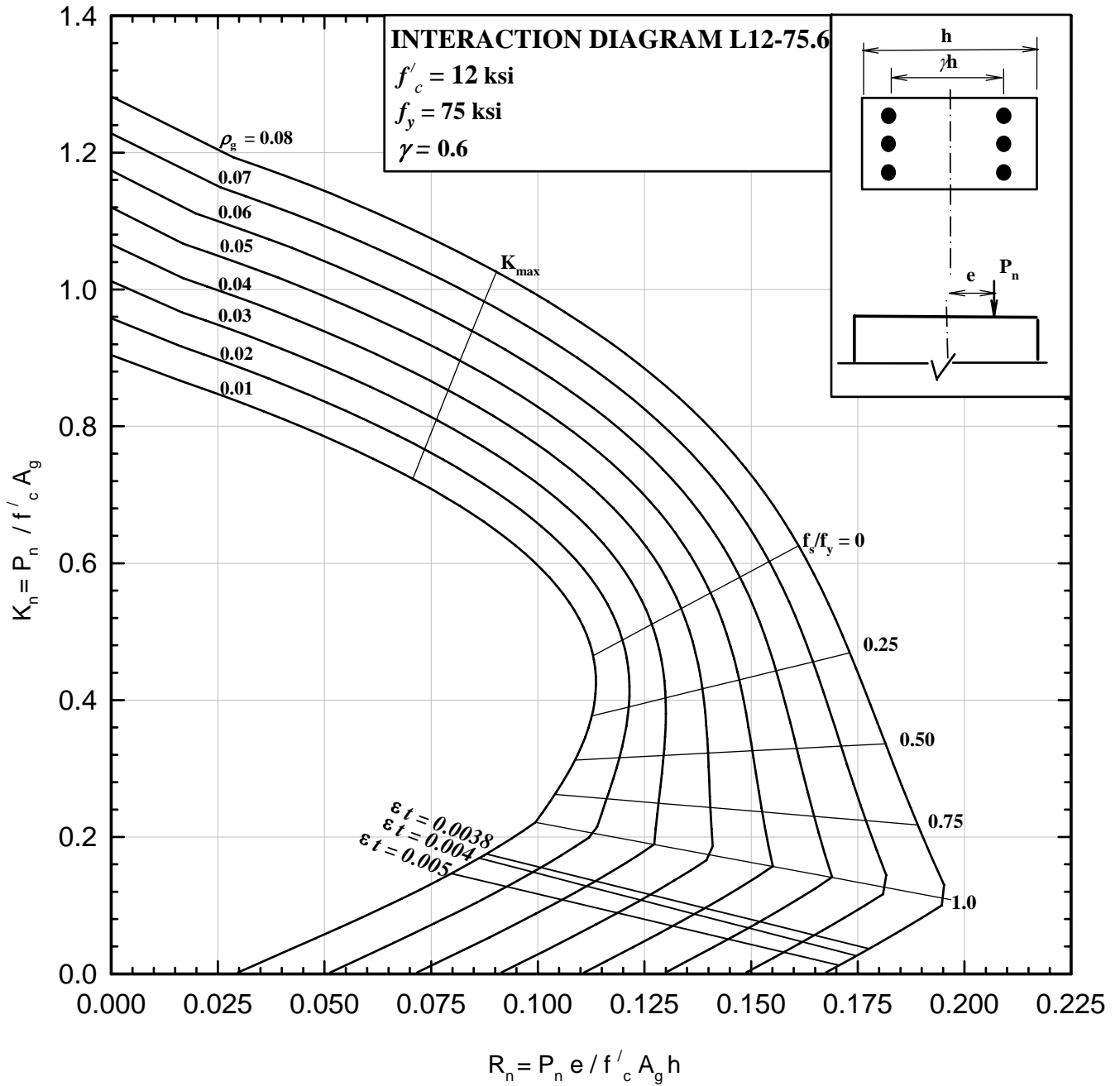

COLUMNS 3.12.2 - Nominal load-moment strength interaction diagram, L12-75.7

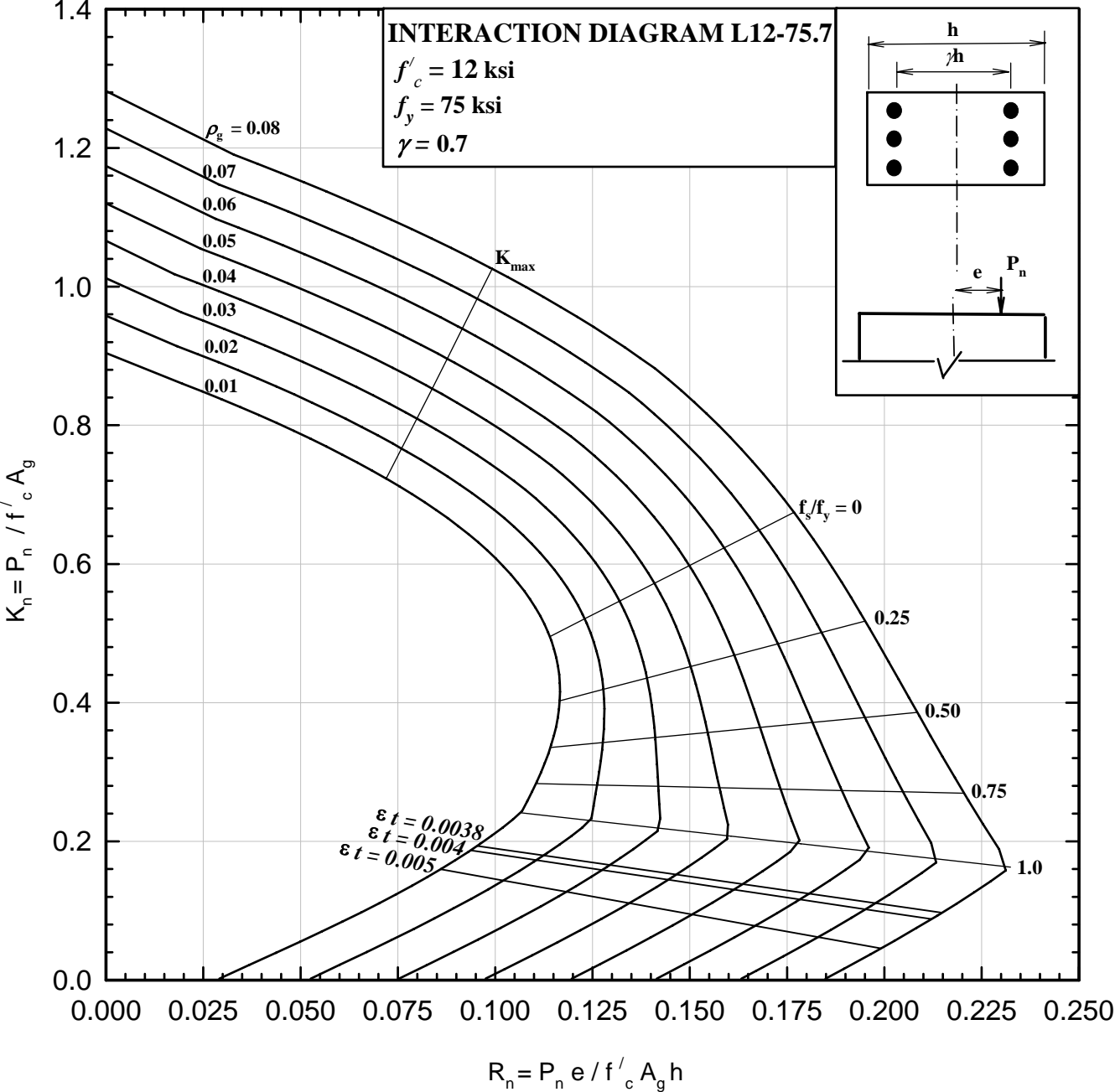

COLUMNS 3.12.3 - Nominal load-moment strength interaction diagram, L12-75.8

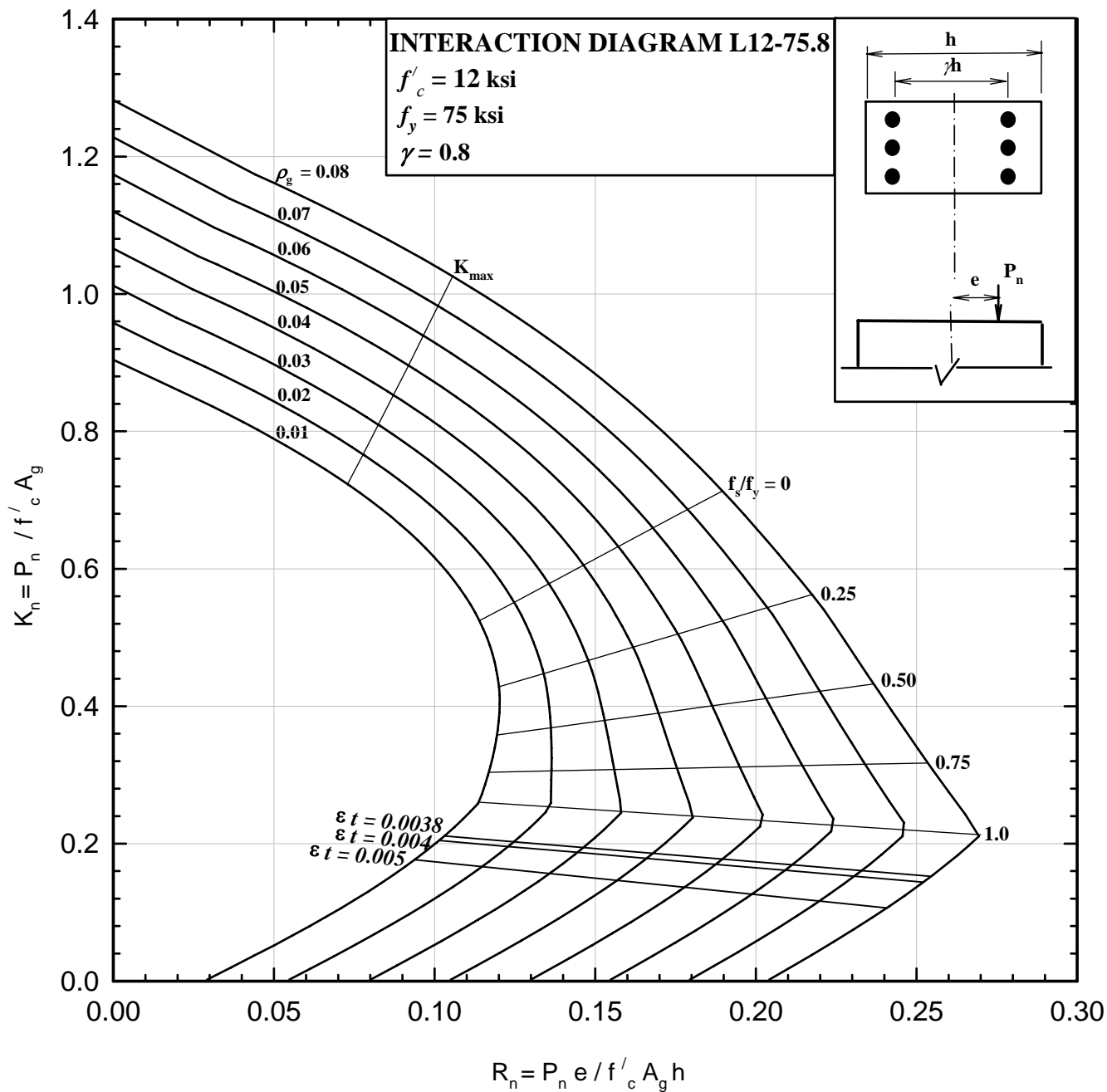

COLUMNS 3.12.4 - Nominal load-moment strength interaction diagram, L12-75.9

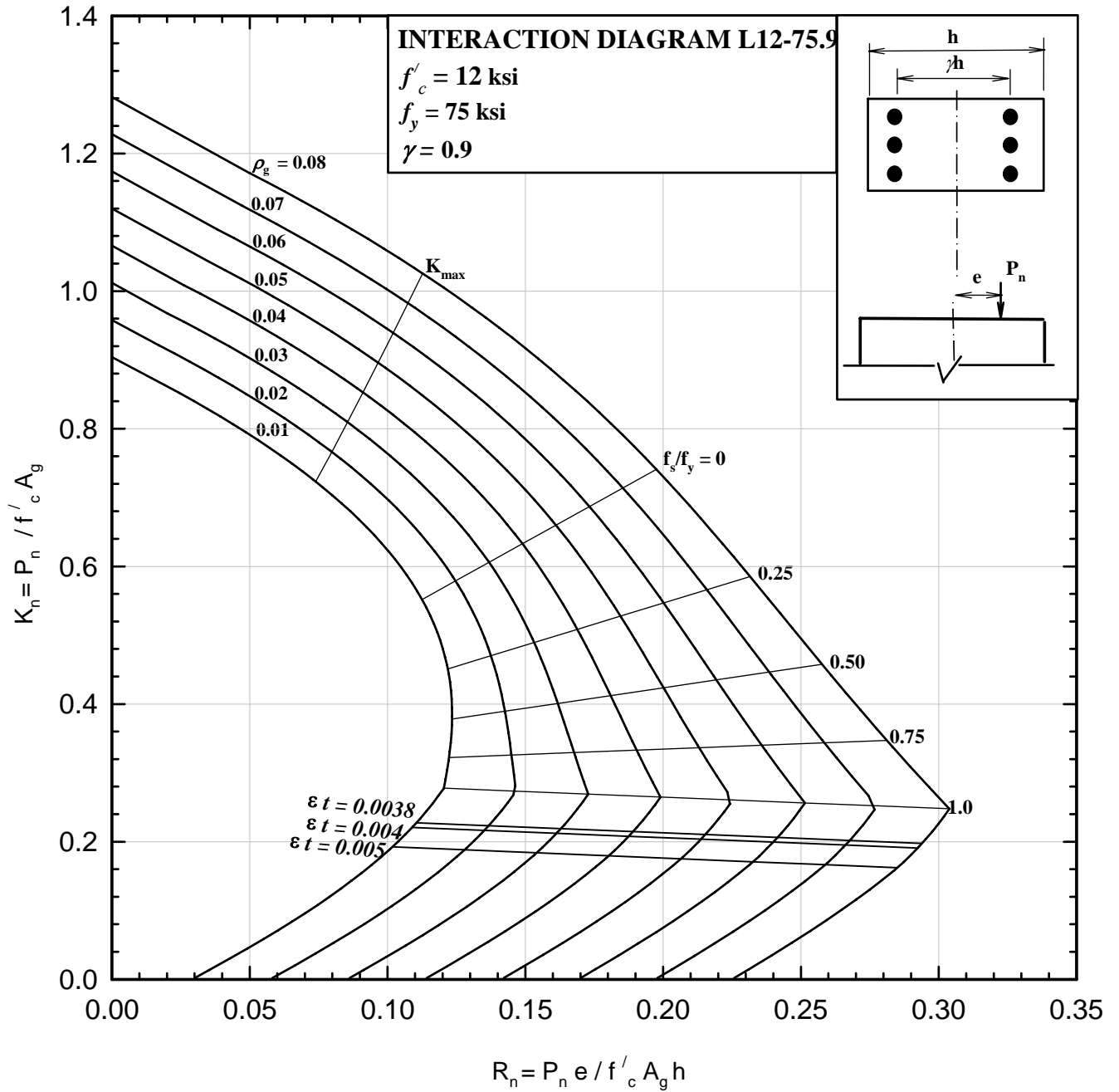

COLUMNS 3.13.1 - Nominal load-moment strength interaction diagram, C3-60.6

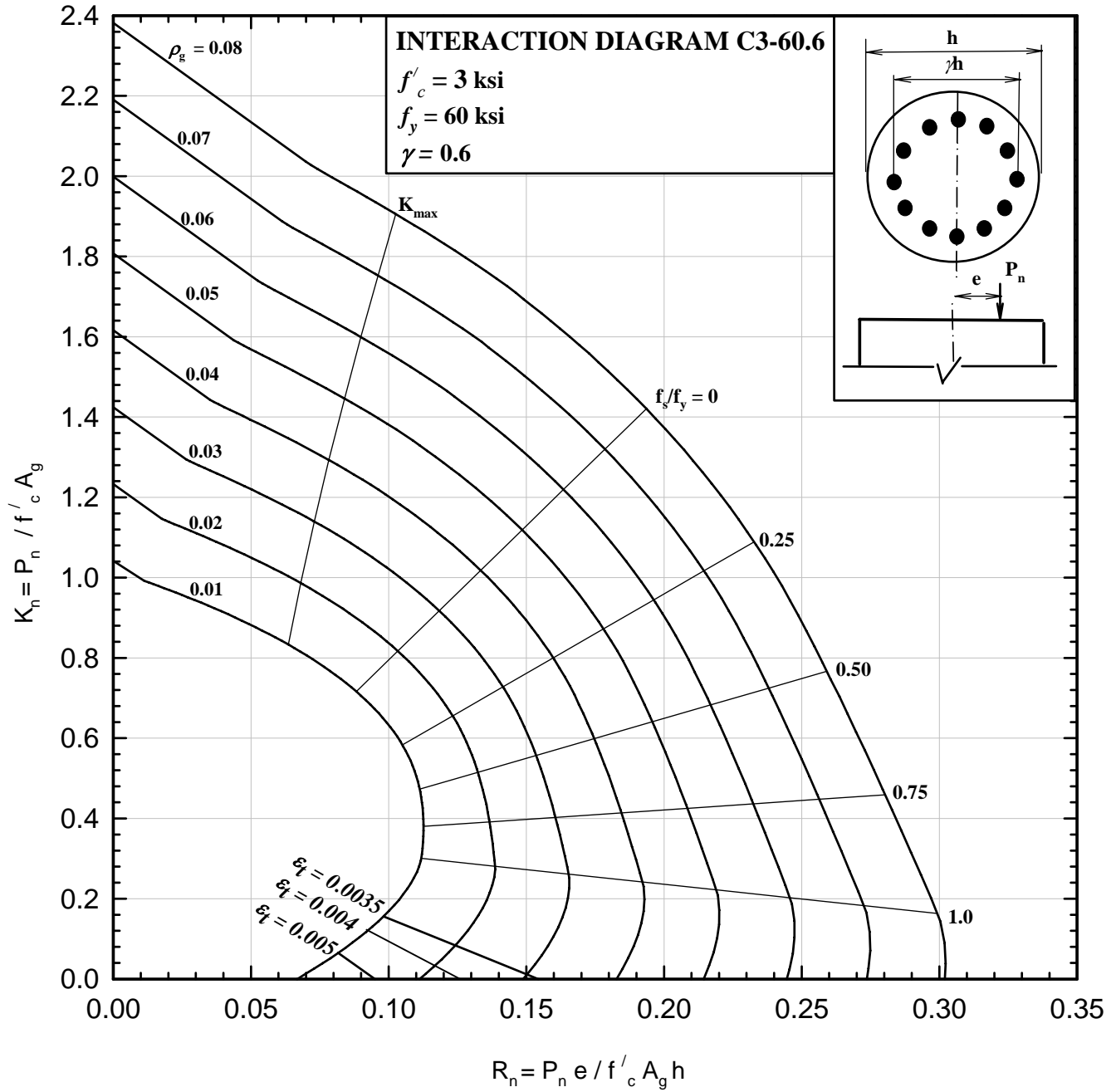

COLUMNS 3.13.2 - Nominal load-moment strength interaction diagram, C3-60.7

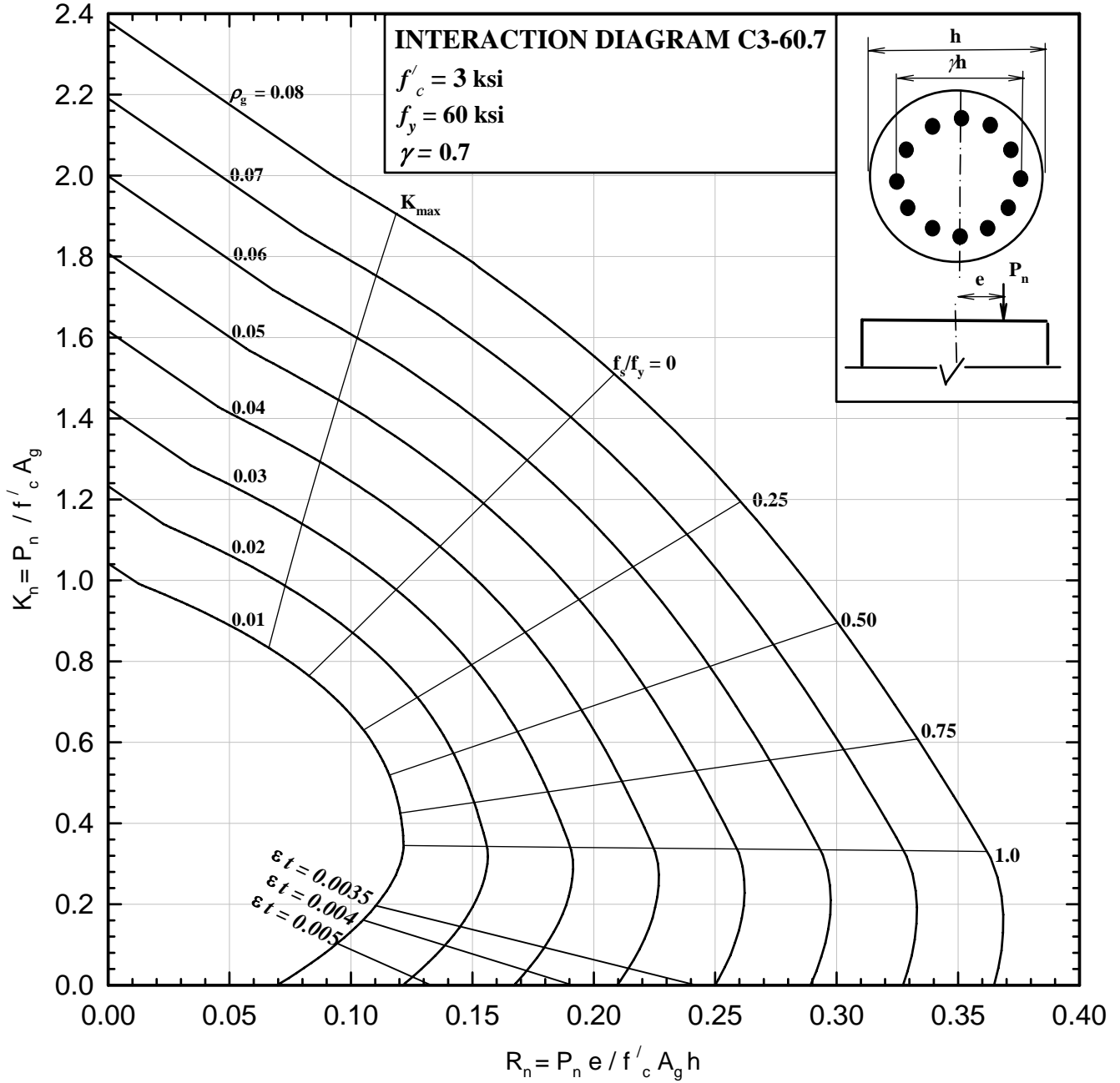

COLUMNS 3.13.3 - Nominal load-moment strength interaction diagram, C3-60.8

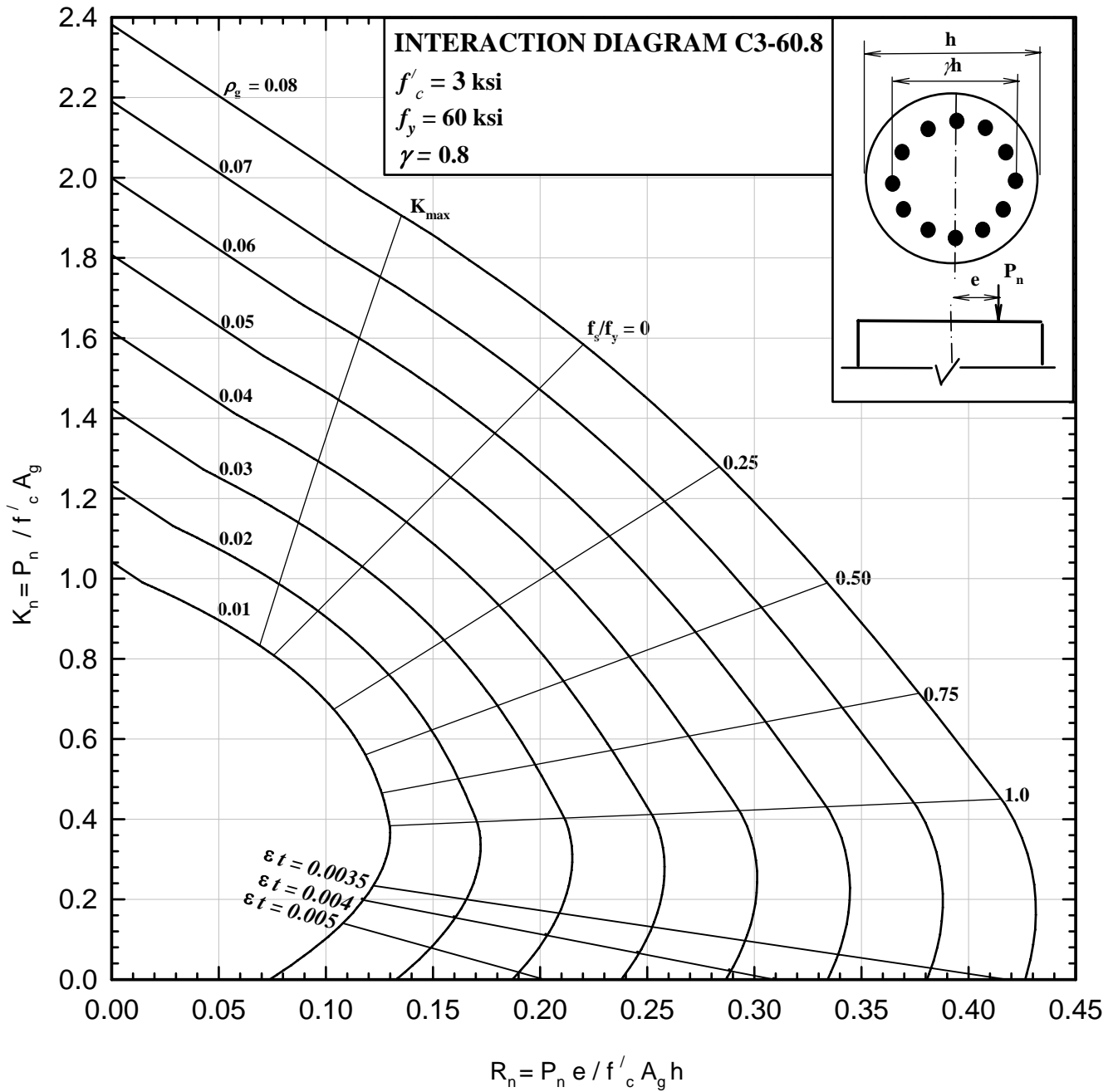

COLUMNS 3.13.4 - Nominal load-moment strength interaction diagram, C3-60.9

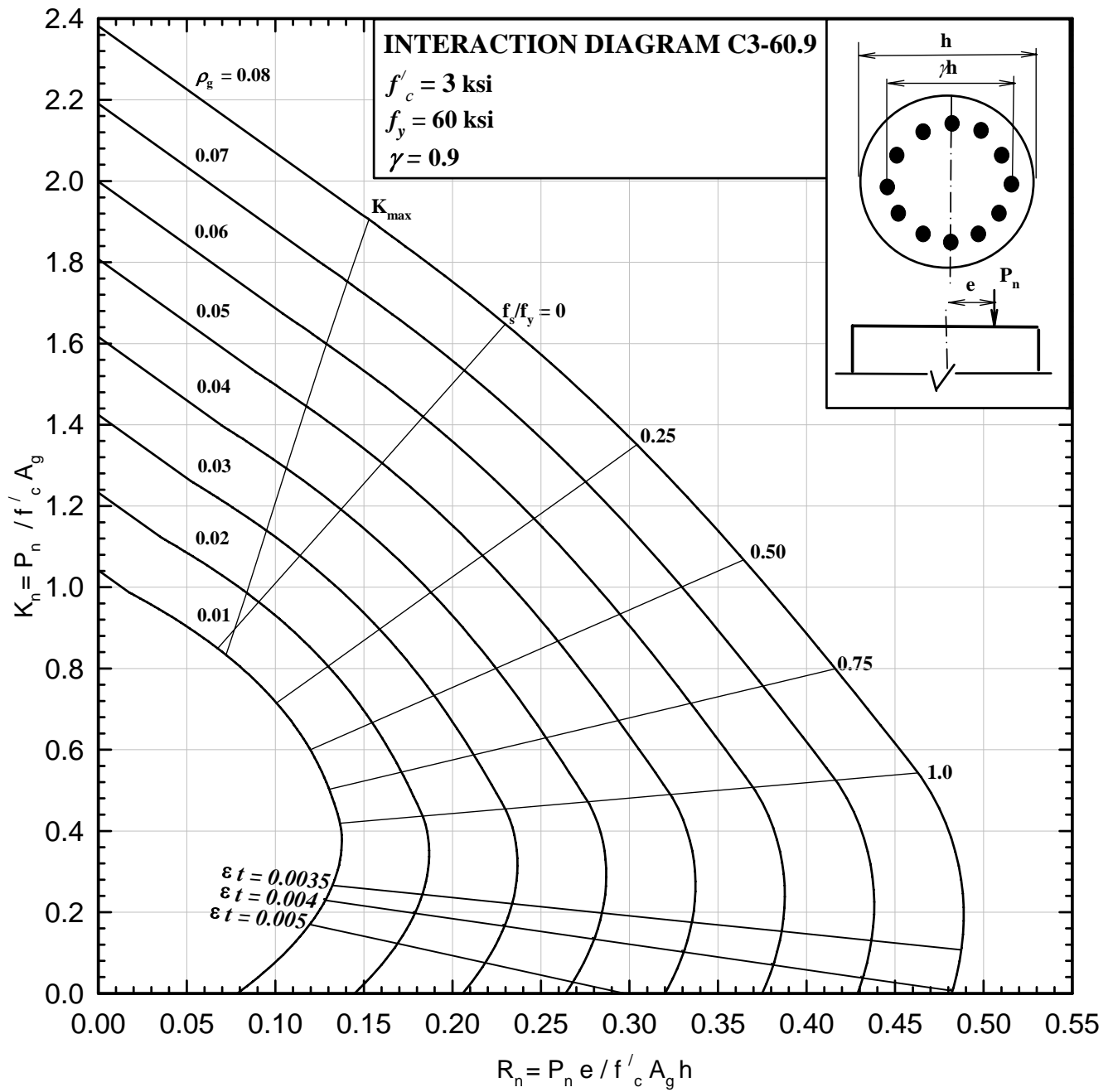

COLUMNS 3.14.1 - Nominal load-moment strength interaction diagram, C4-60.6

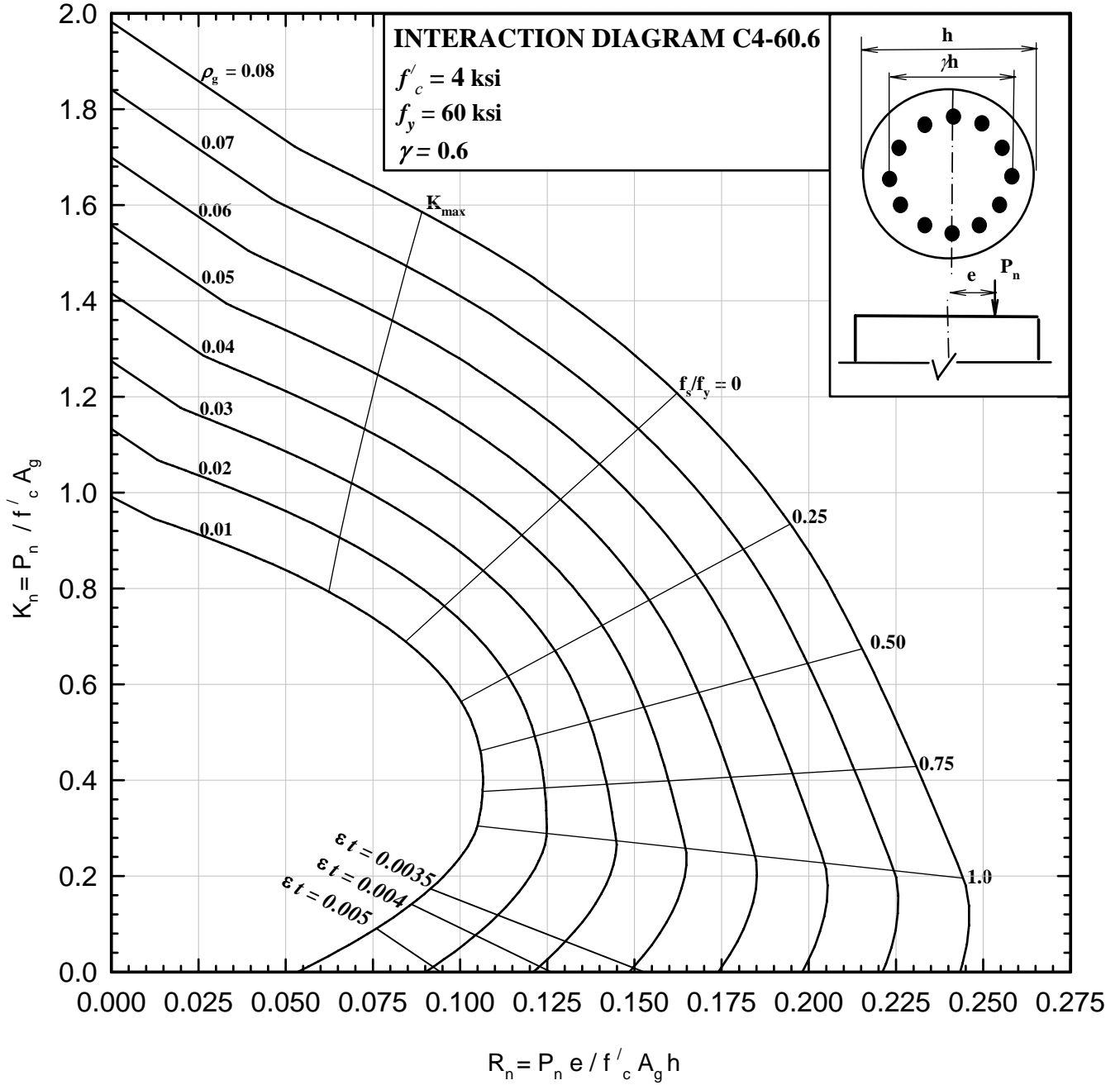

COLUMNS 3.14.2 - Nominal load-moment strength interaction diagram, C4-60.7

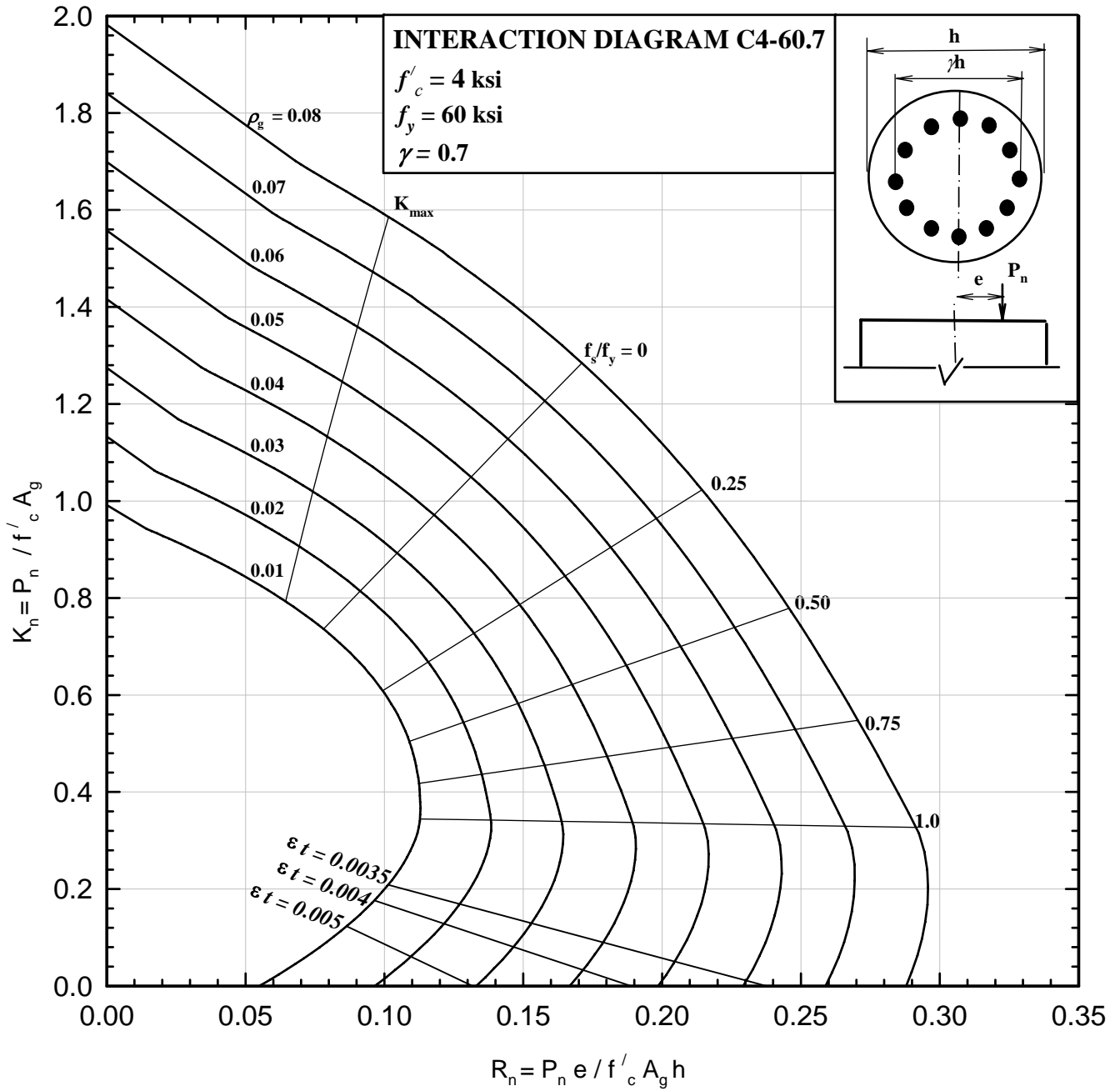

COLUMNS 3.14.3 - Nominal load-moment strength interaction diagram, C4-60.8

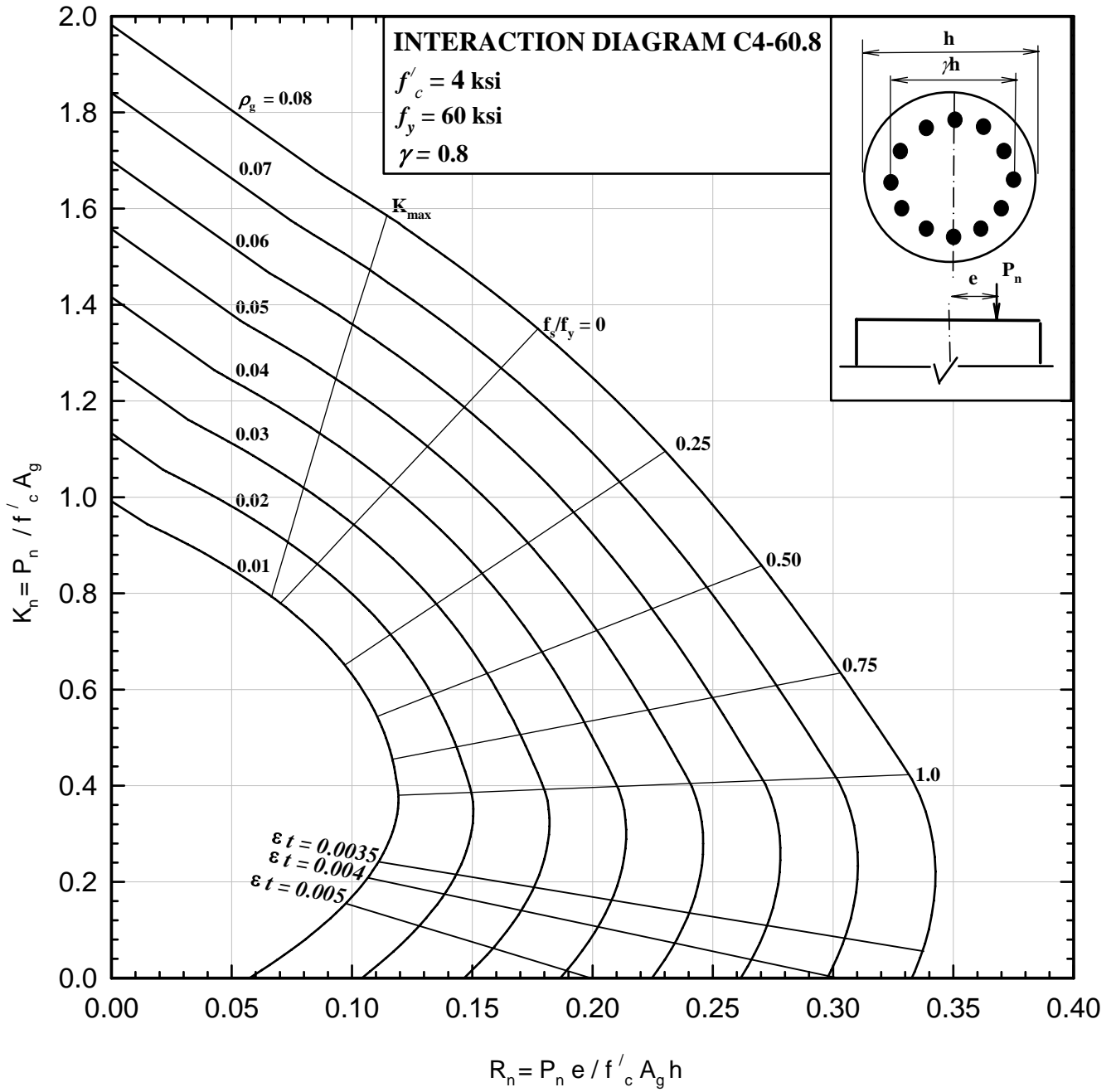

COLUMNS 3.14.4 - Nominal load-moment strength interaction diagram, C4-60.9

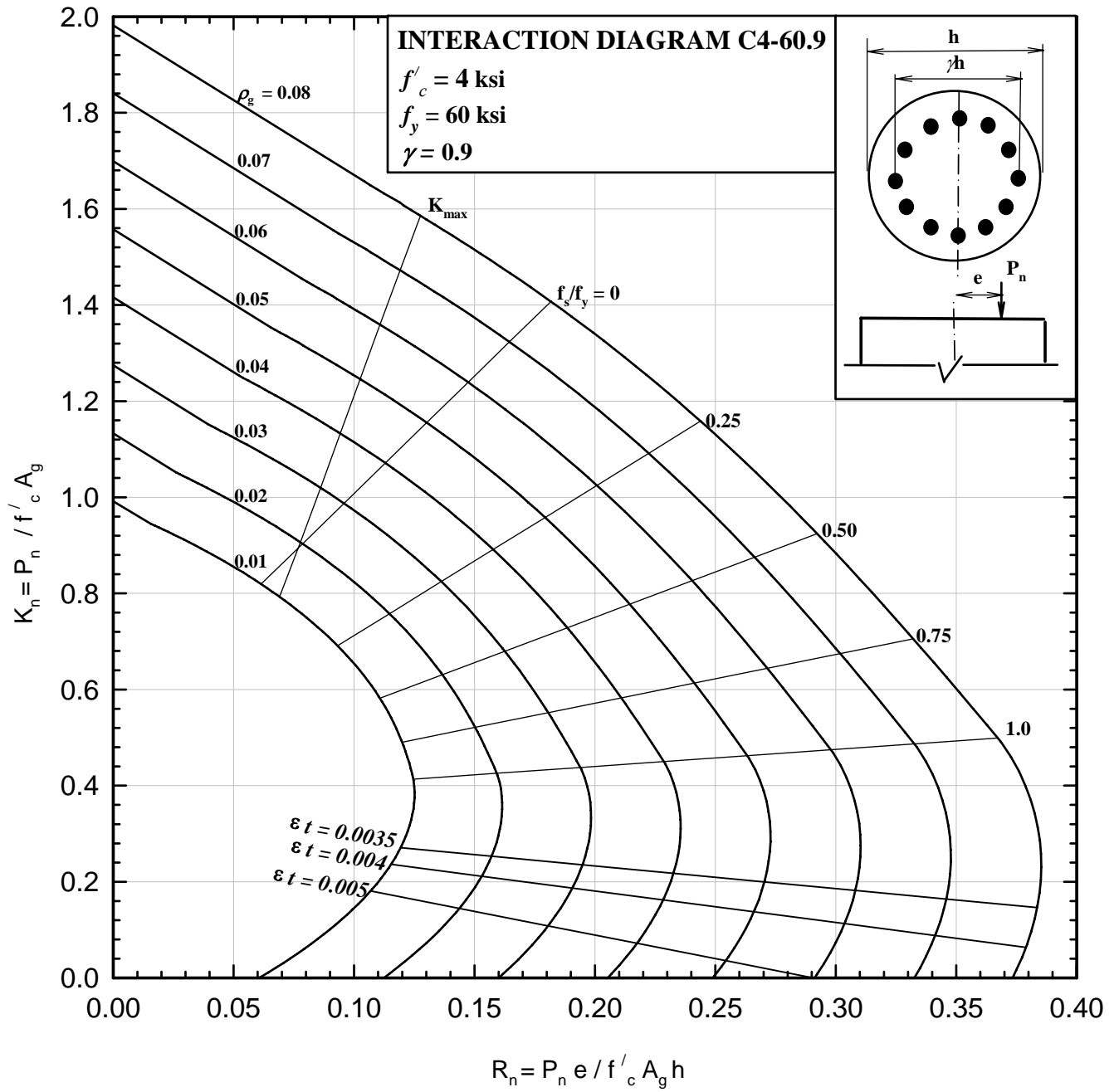

COLUMNS 3.15.1 - Nominal load-moment strength interaction diagram, C5-60.6

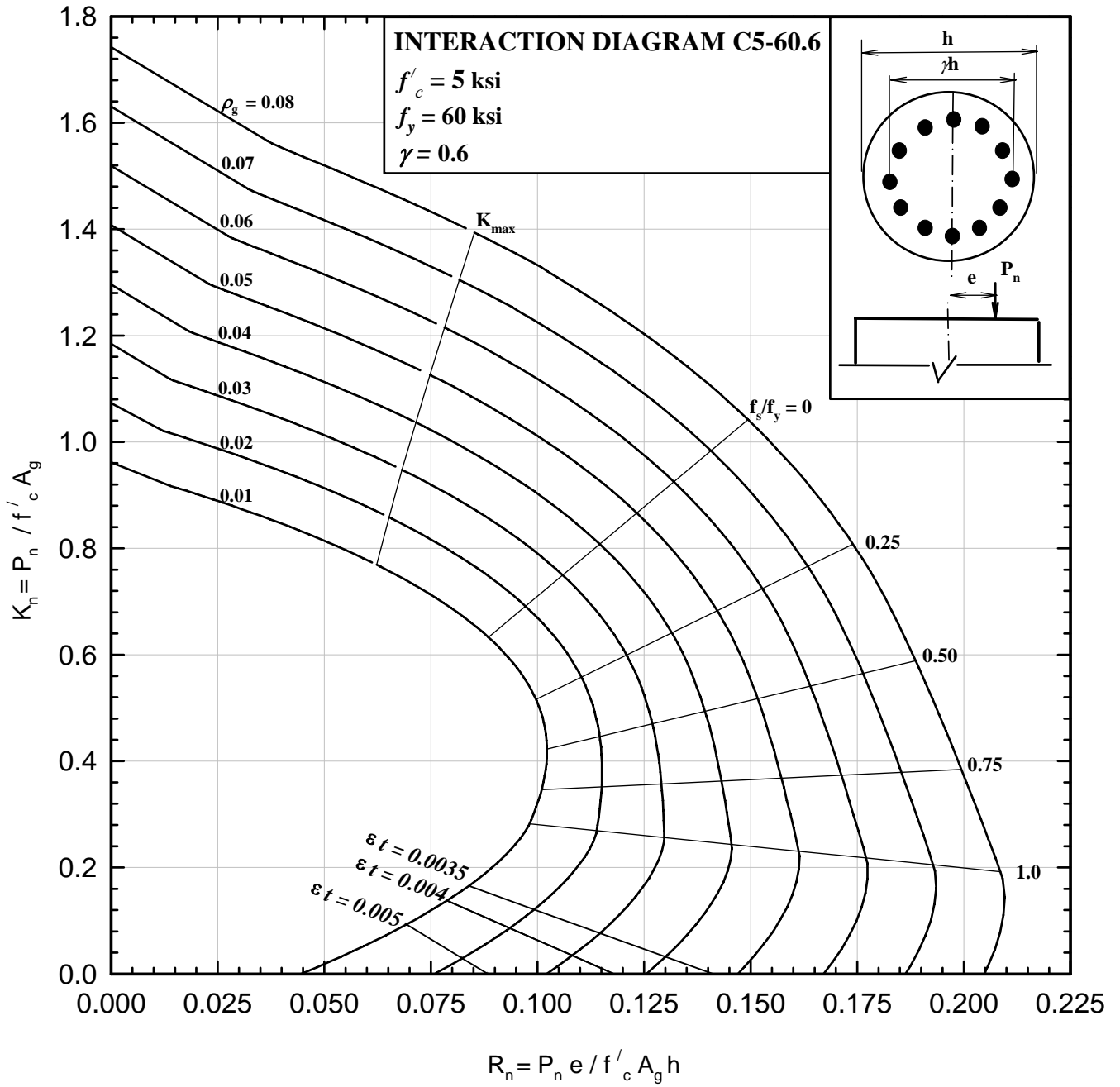

COLUMNS 3.15.2 - Nominal load-moment strength interaction diagram, C5-60.7

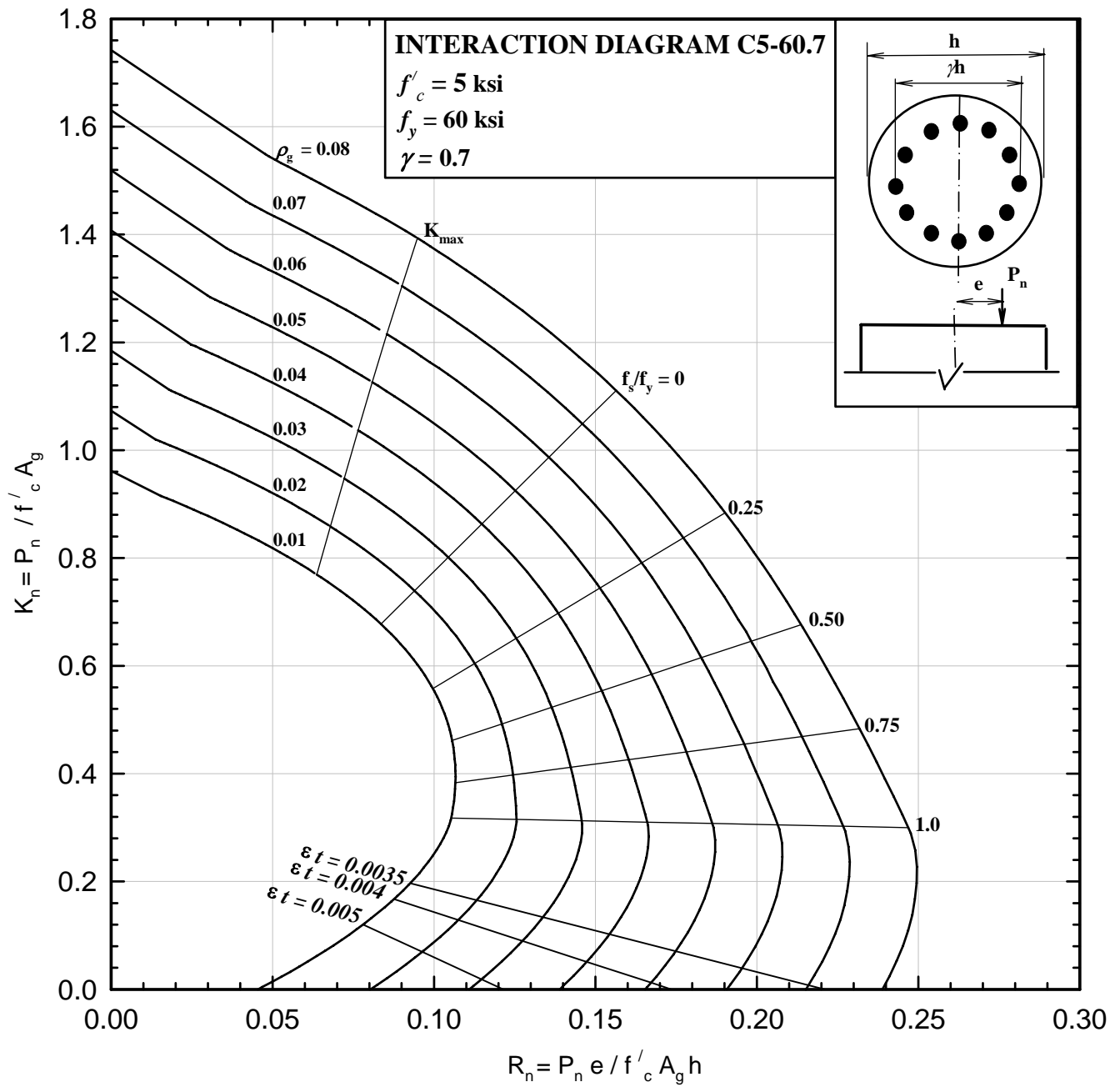

COLUMNS 3.15.3 - Nominal load-moment strength interaction diagram, C5-60.8

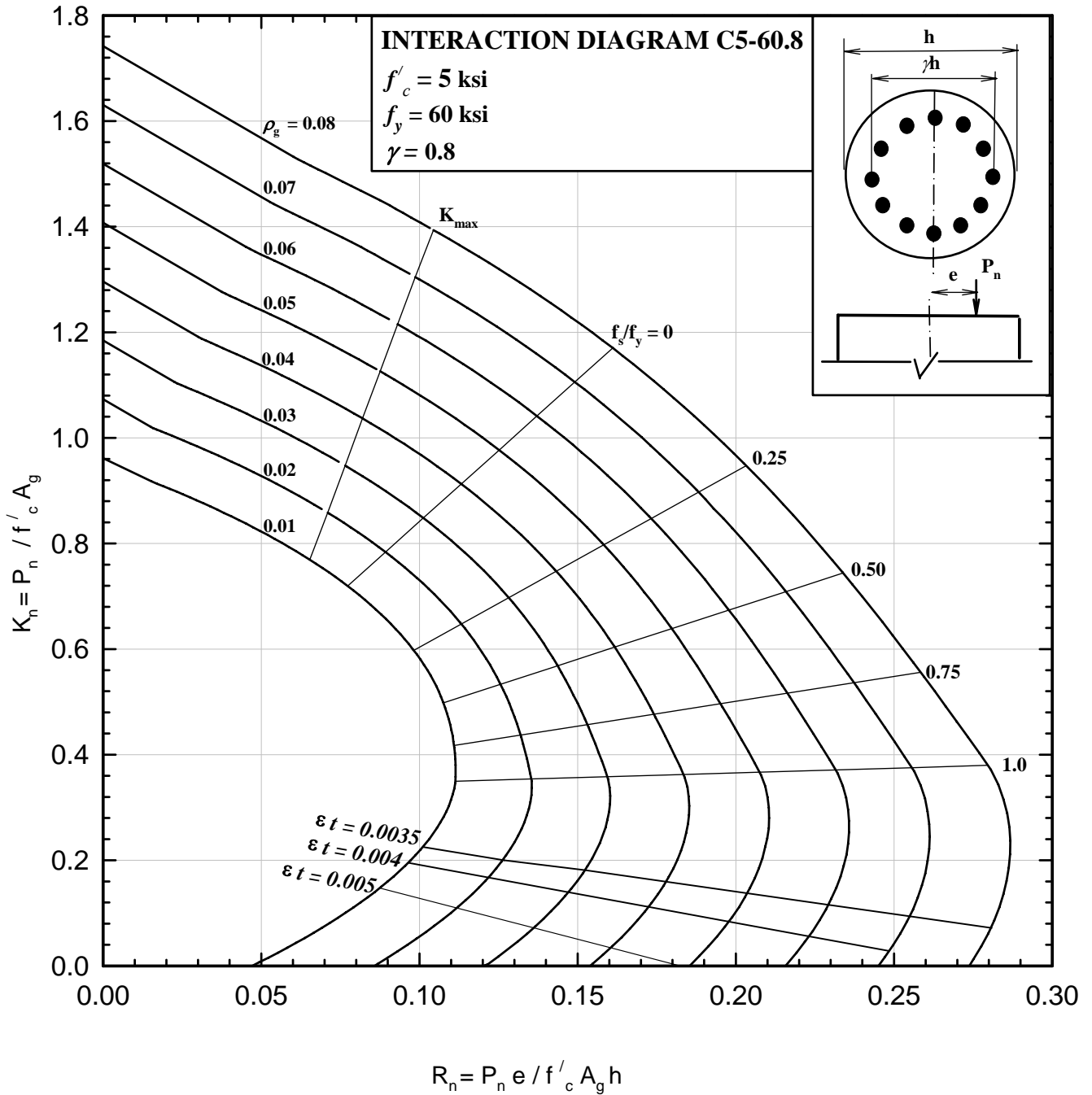

COLUMNS 3.15.4 - Nominal load-moment strength interaction diagram, C5-60.9

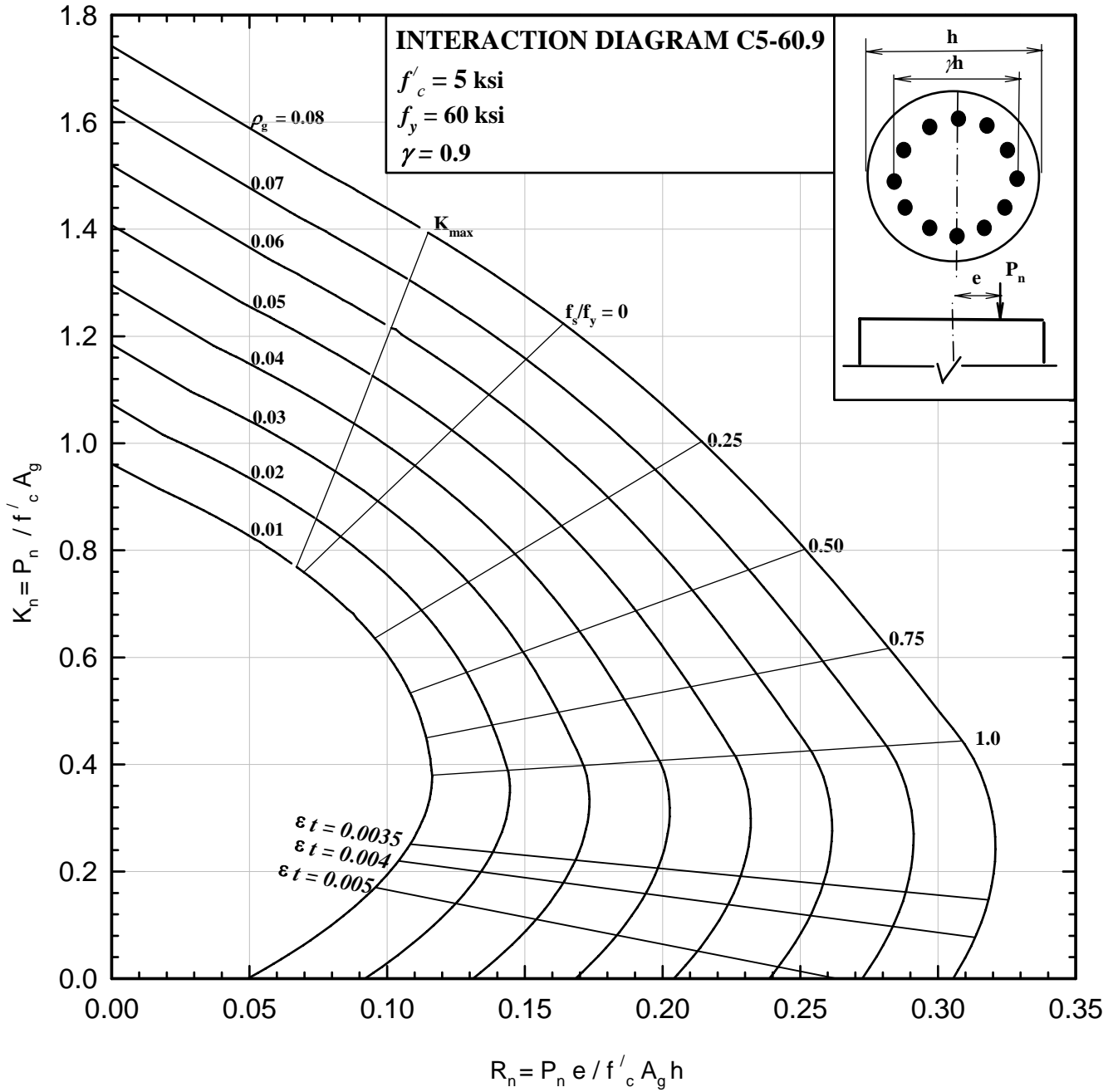

COLUMNS 3.16.1 - Nominal load-moment strength interaction diagram, C6-60.6

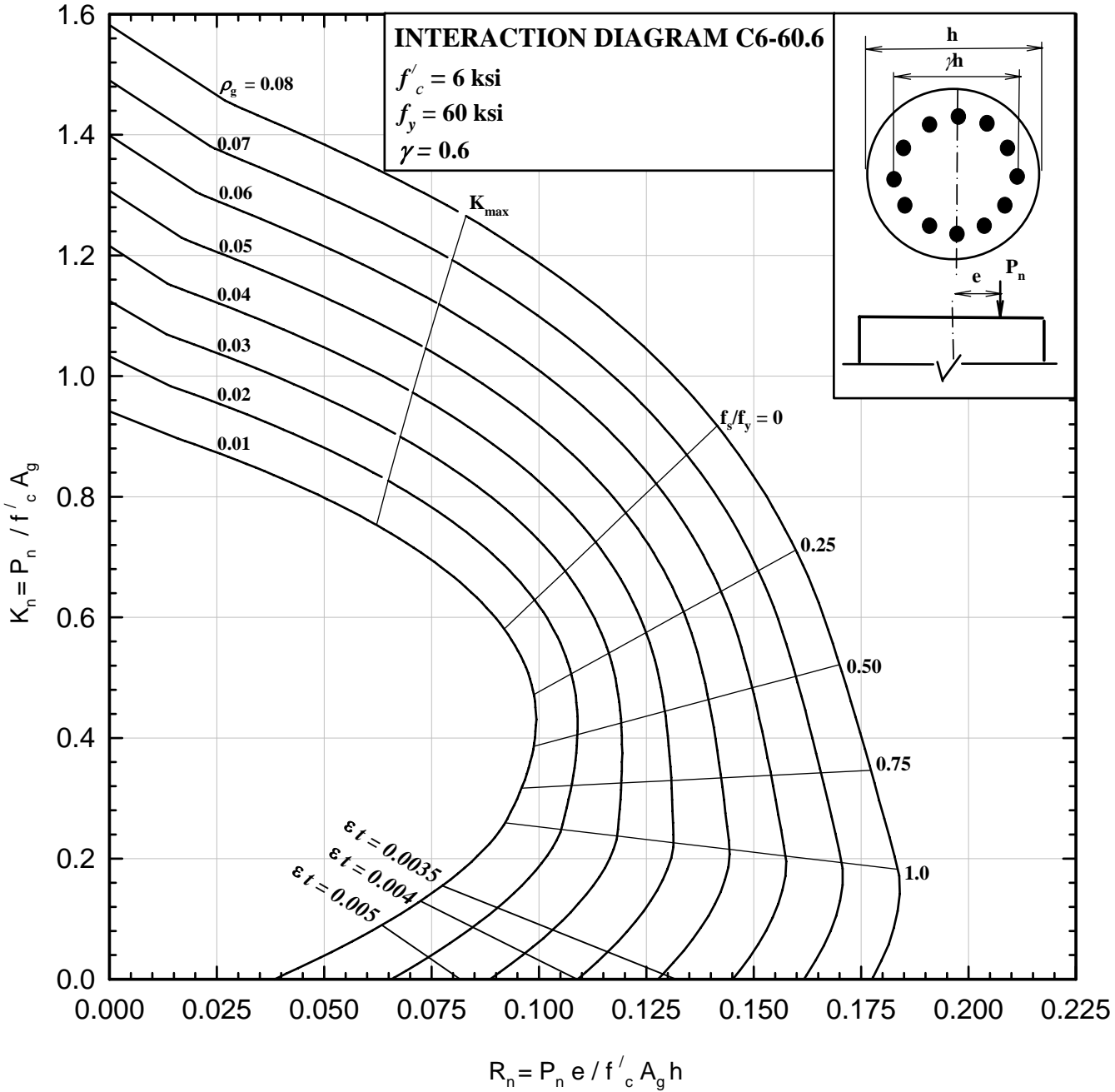

COLUMNS 3.16.2 - Nominal load-moment strength interaction diagram, C6-60.7

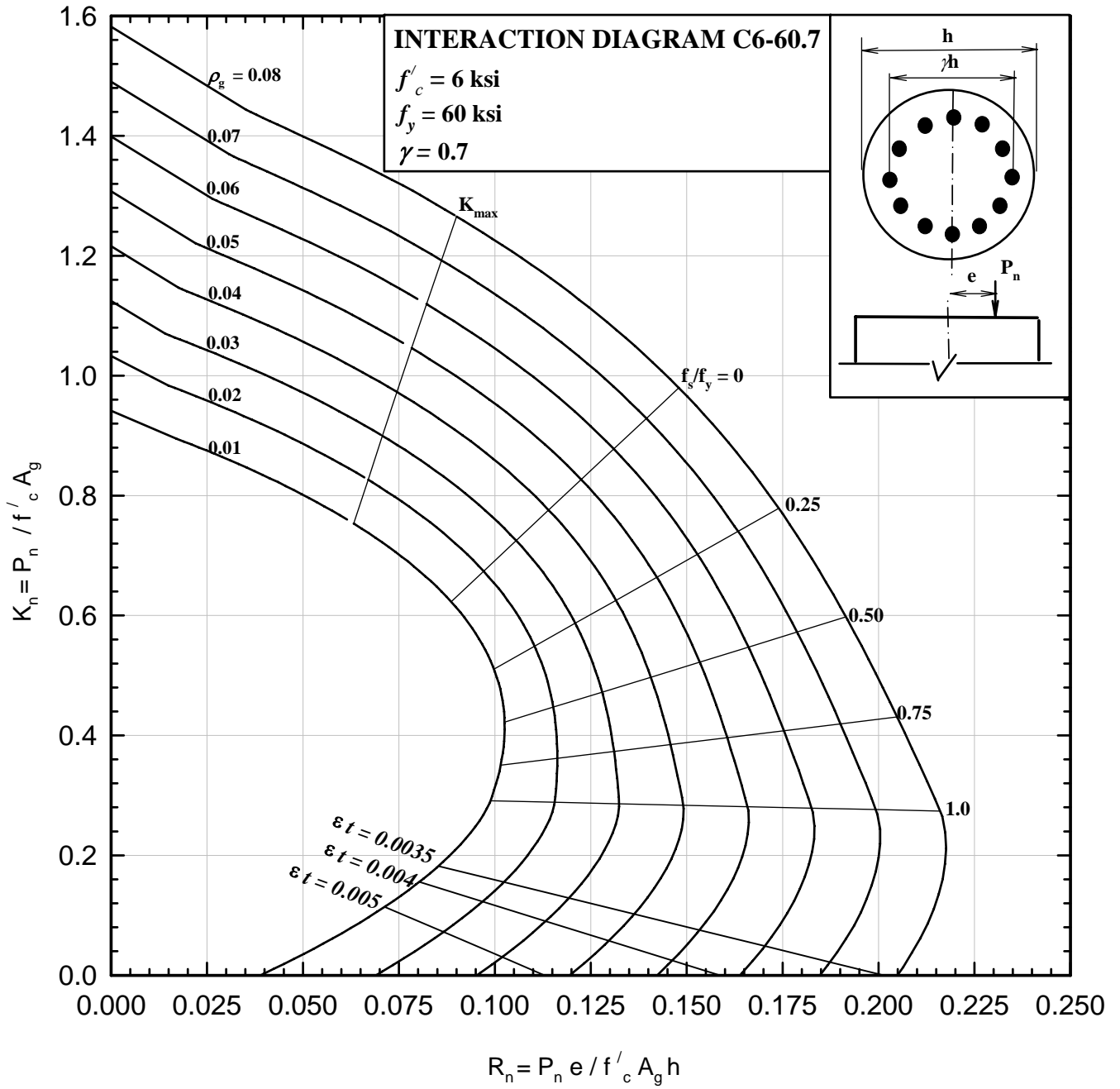

COLUMNS 3.16.3 - Nominal load-moment strength interaction diagram, C6-60.8

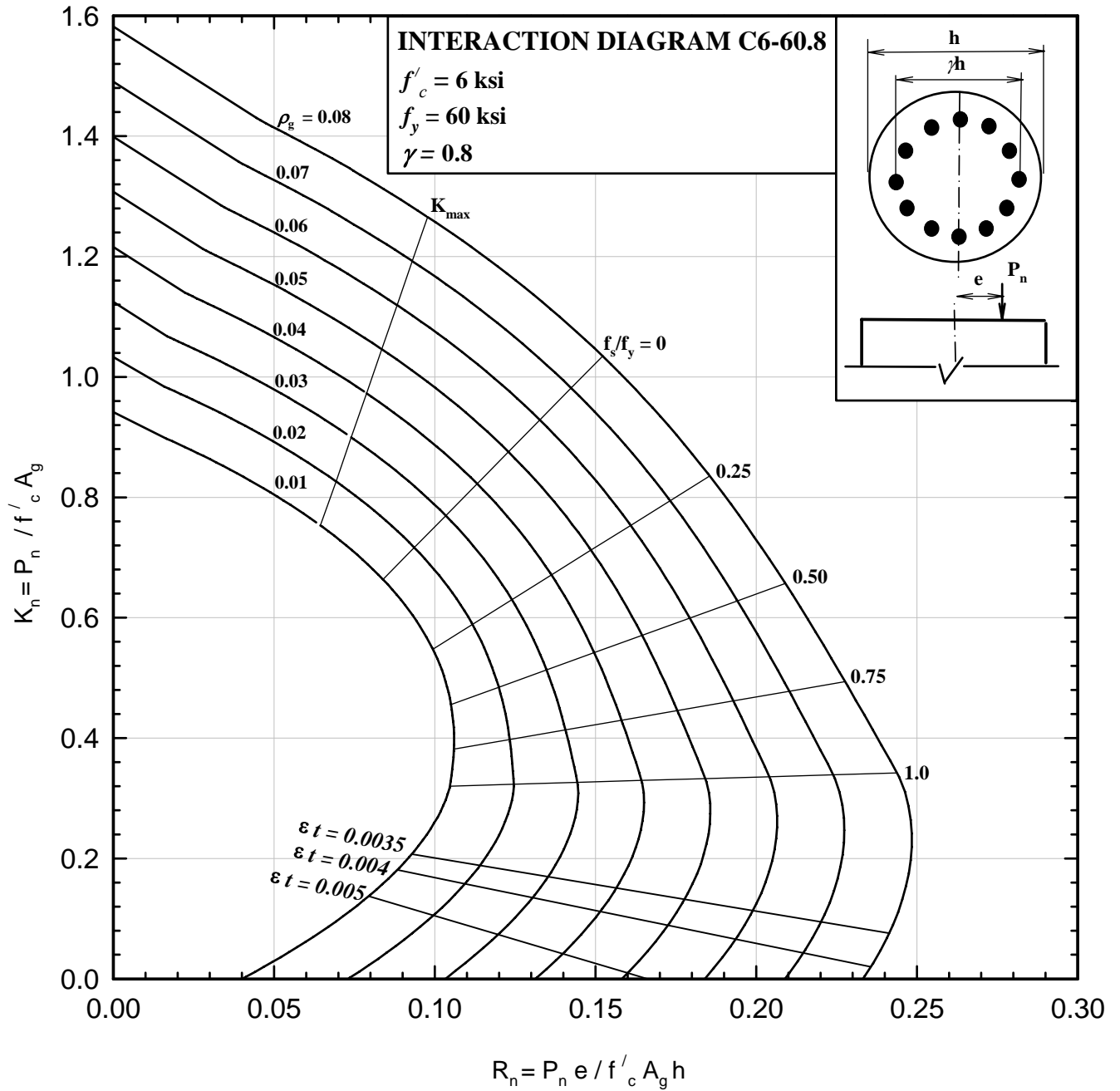

COLUMNS 3.16.4 - Nominal load-moment strength interaction diagram, C6-60.9

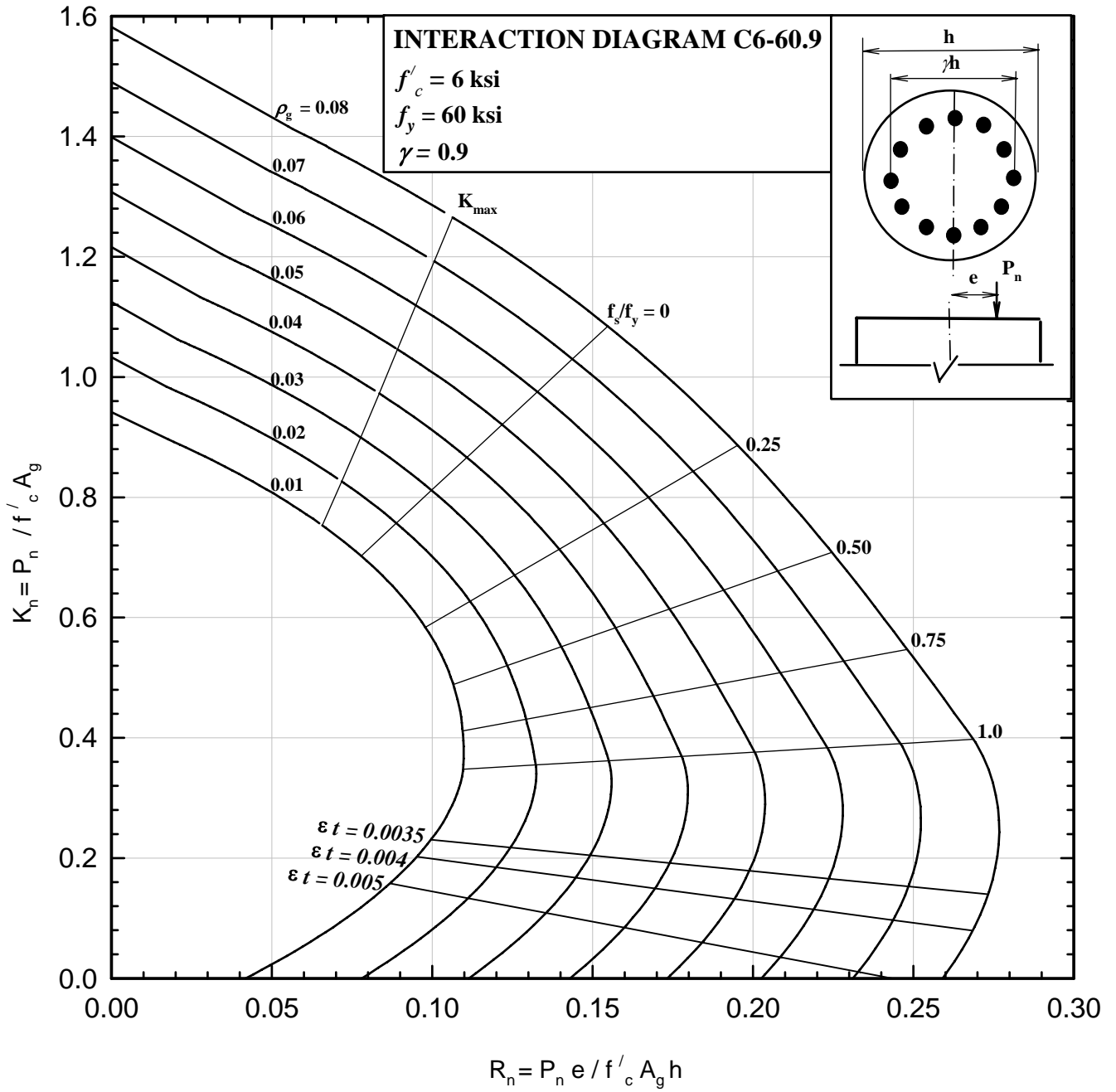

COLUMNS 3.17.1 - Nominal load-moment strength interaction diagram, C9-75.6

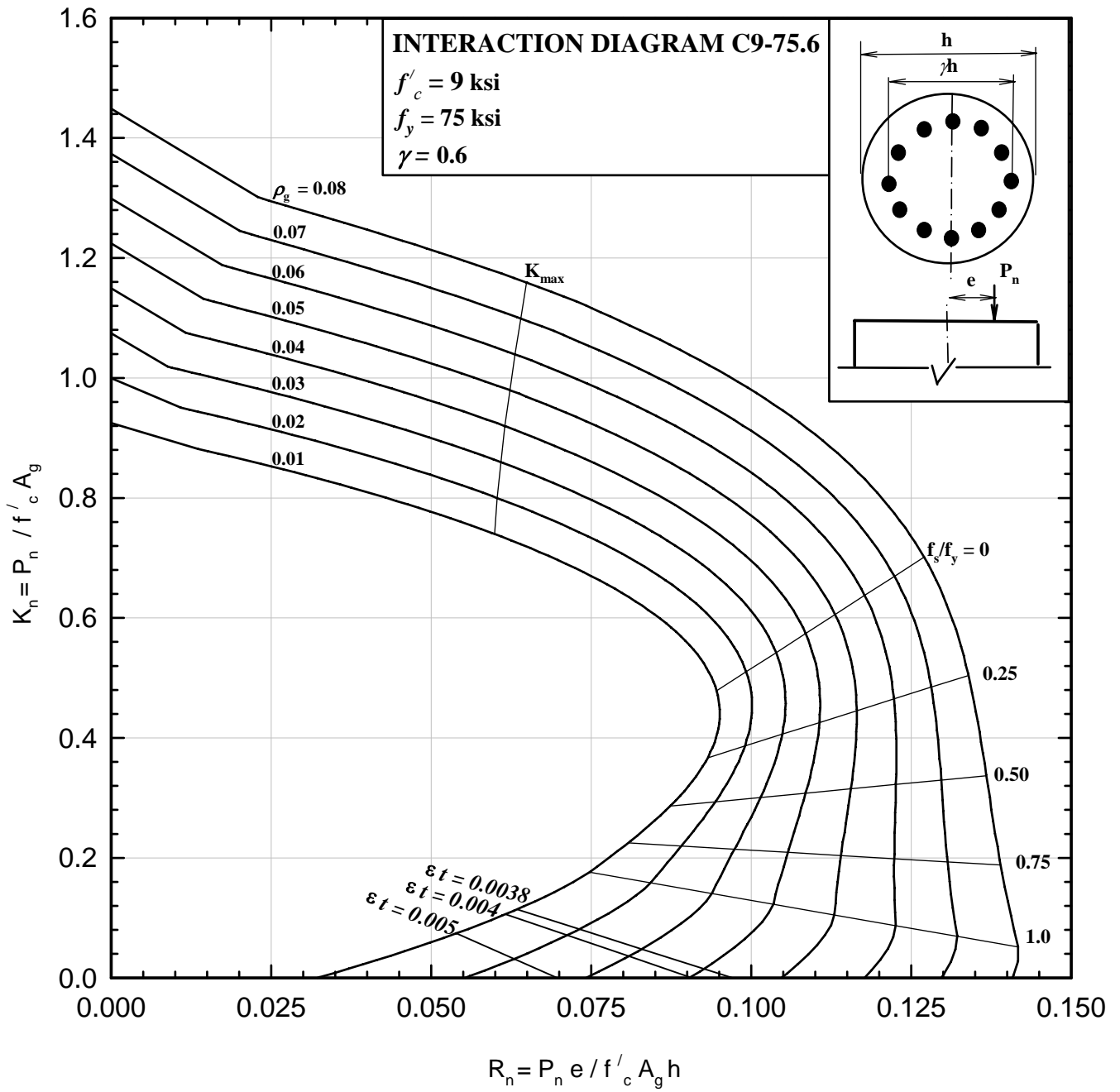

COLUMNS 3.17.2 - Nominal load-moment strength interaction diagram, C9-75.7

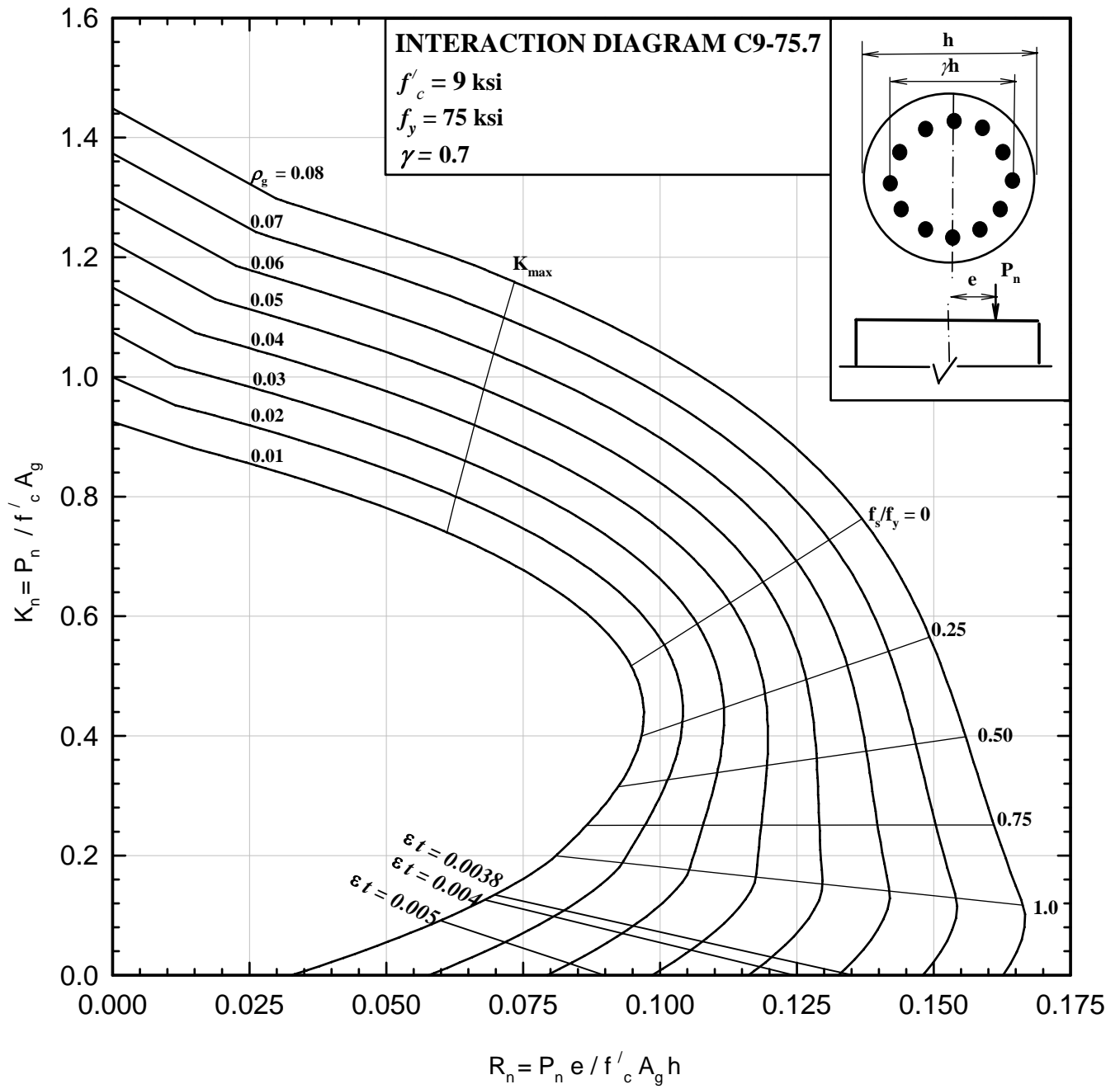

COLUMNS 3.17.3 - Nominal load-moment strength interaction diagram, C9-75.8

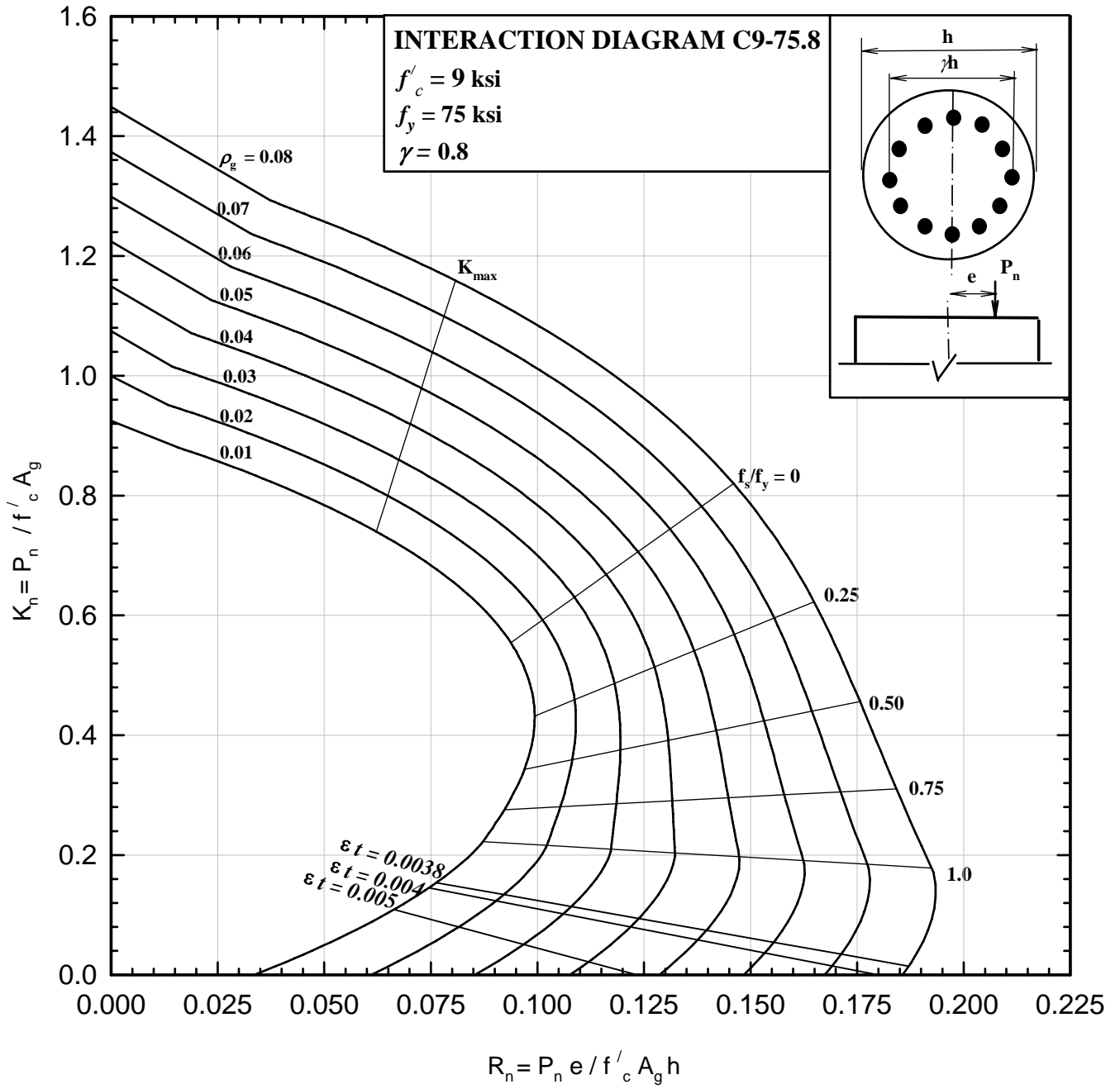

COLUMNS 3.17.4 - Nominal load-moment strength interaction diagram, C9-75.9

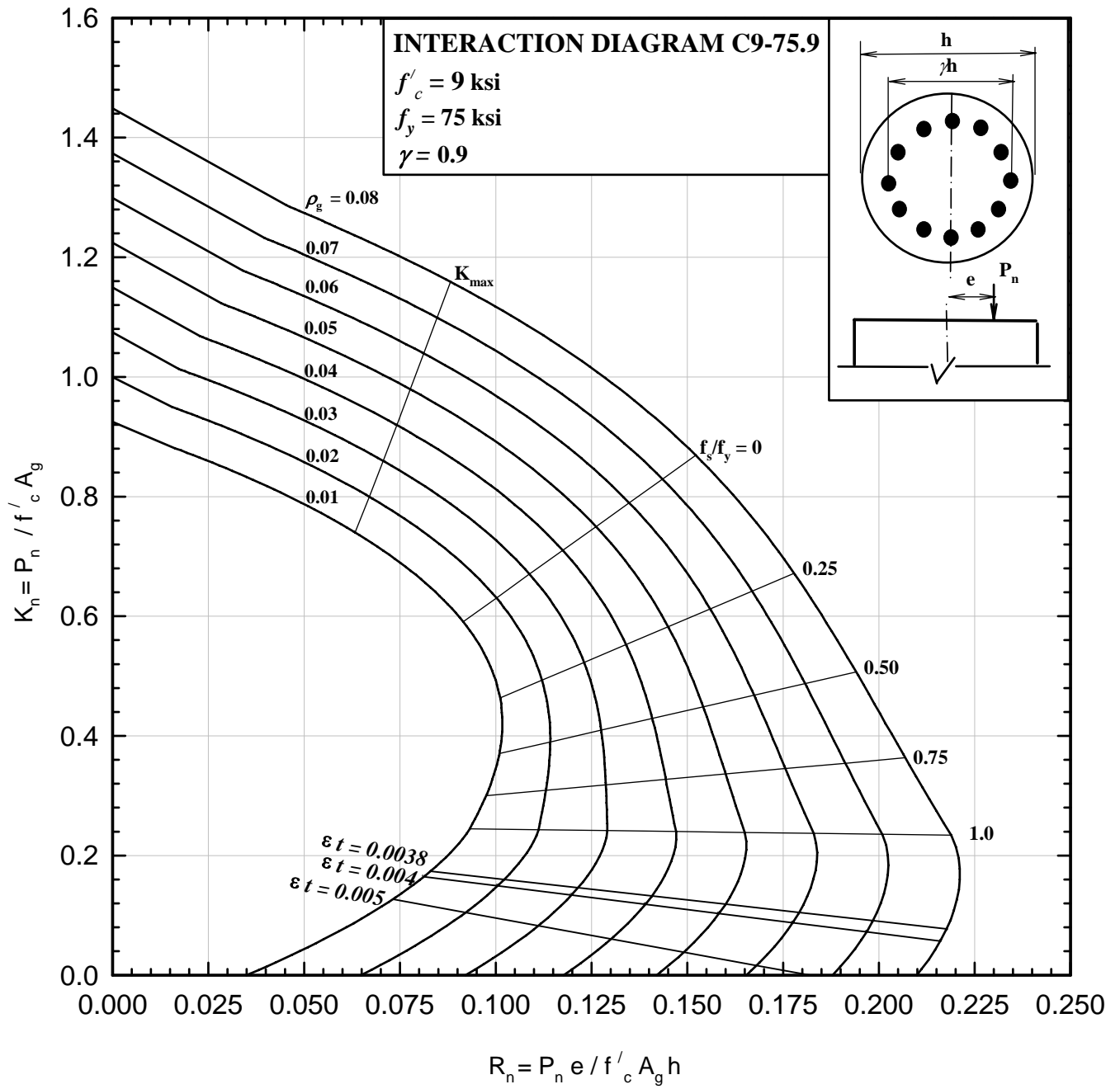

COLUMNS 3.18.1 - Nominal load-moment strength interaction diagram, C12-75.6

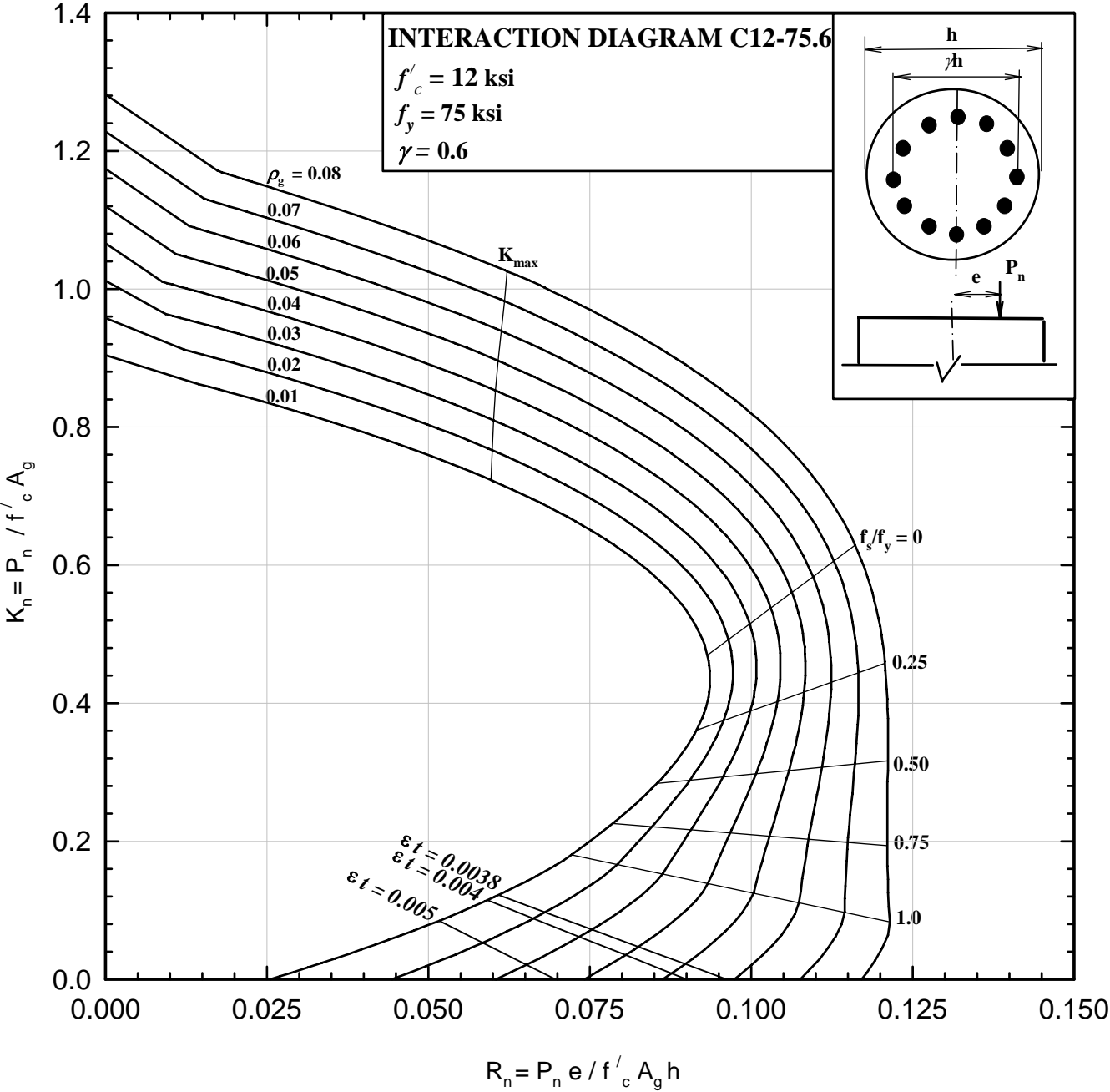

COLUMNS 3.18.2 - Nominal load-moment strength interaction diagram, C12-75.7

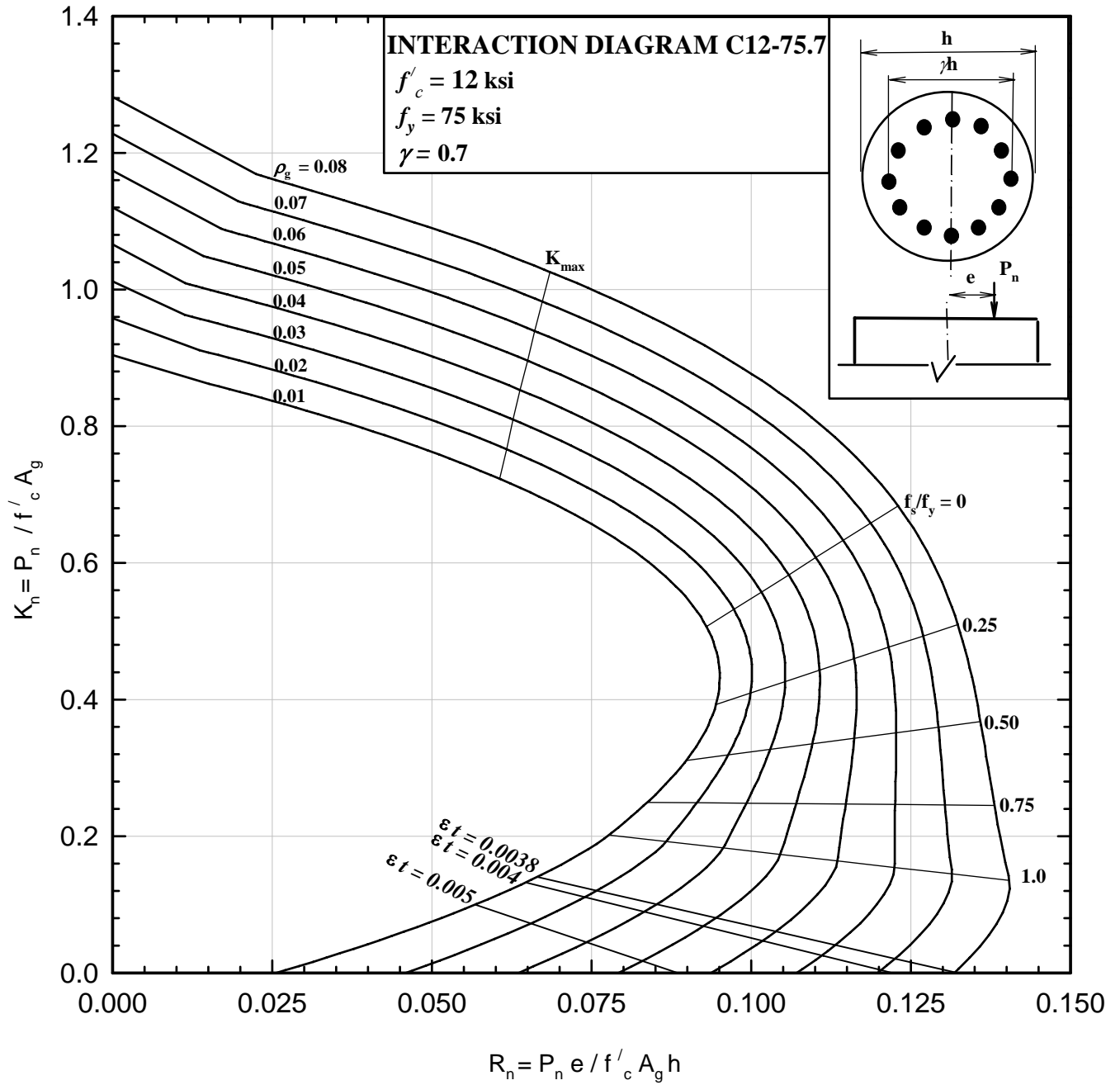

COLUMNS 3.18.3 - Nominal load-moment strength interaction diagram, C12-75.8

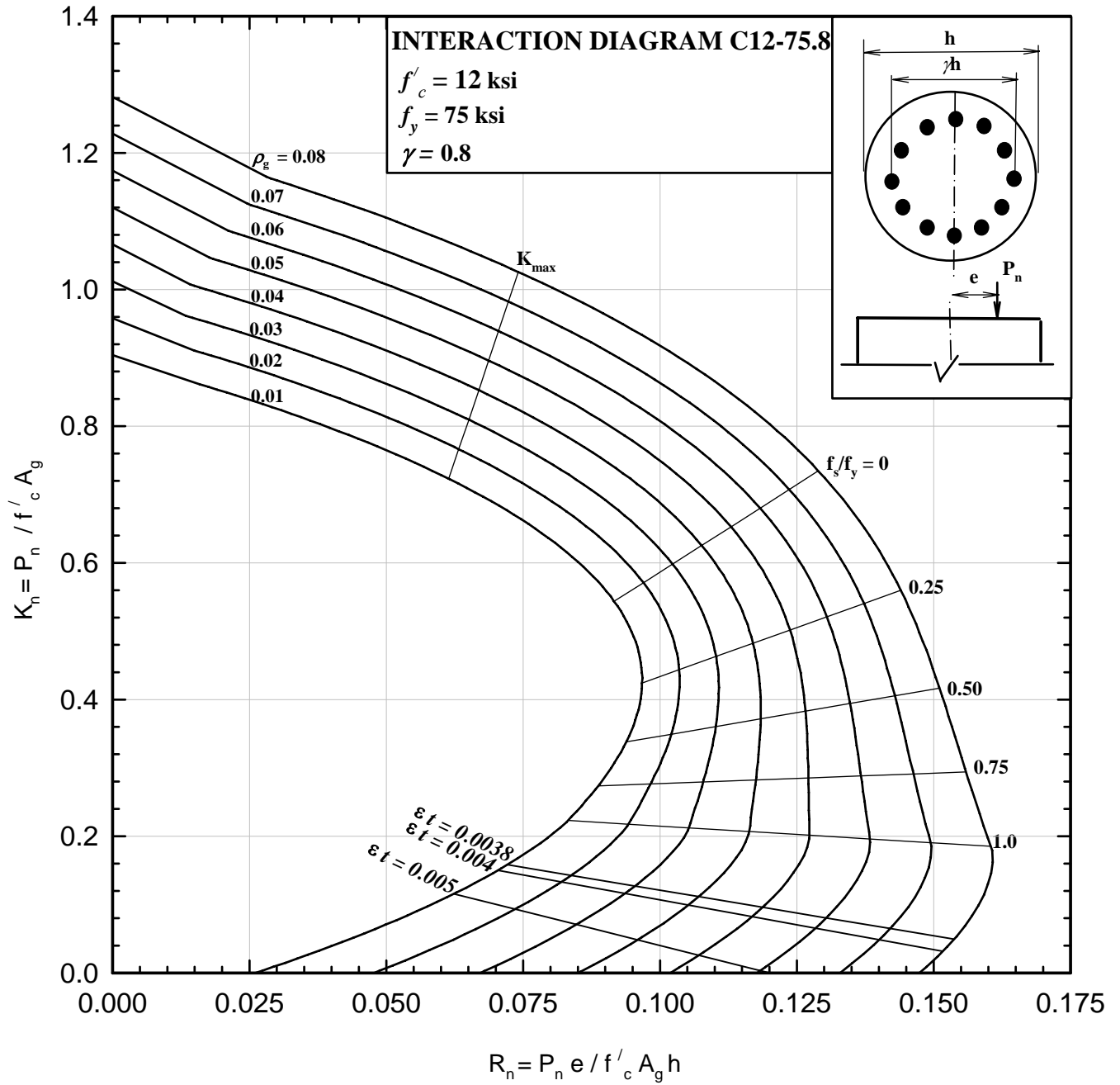

COLUMNS 3.18.4 - Nominal load-moment strength interaction diagram, C12-75.9

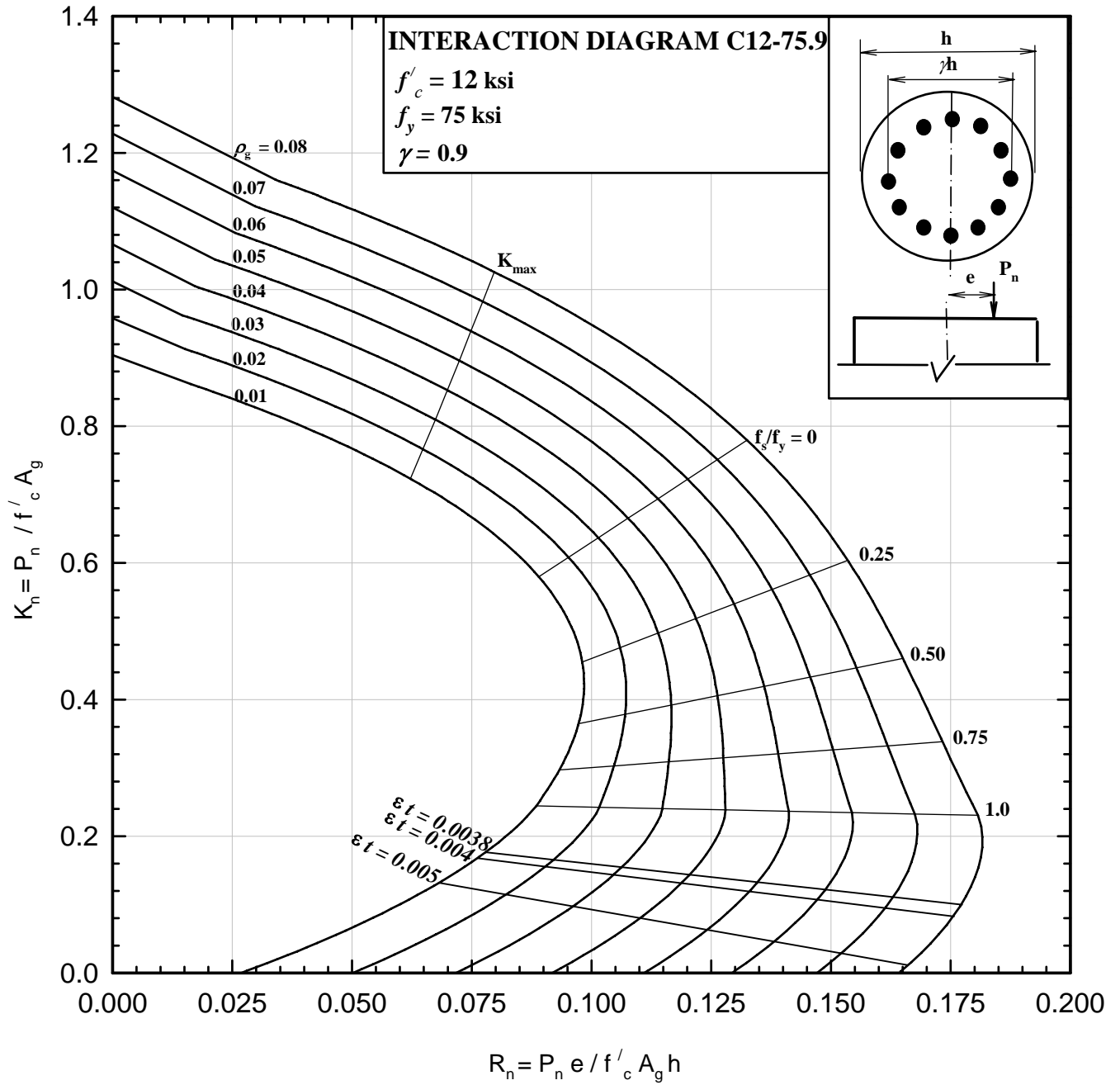

COLUMNS 3.19.1 - Nominal load-moment strength interaction diagram, S3-60.6

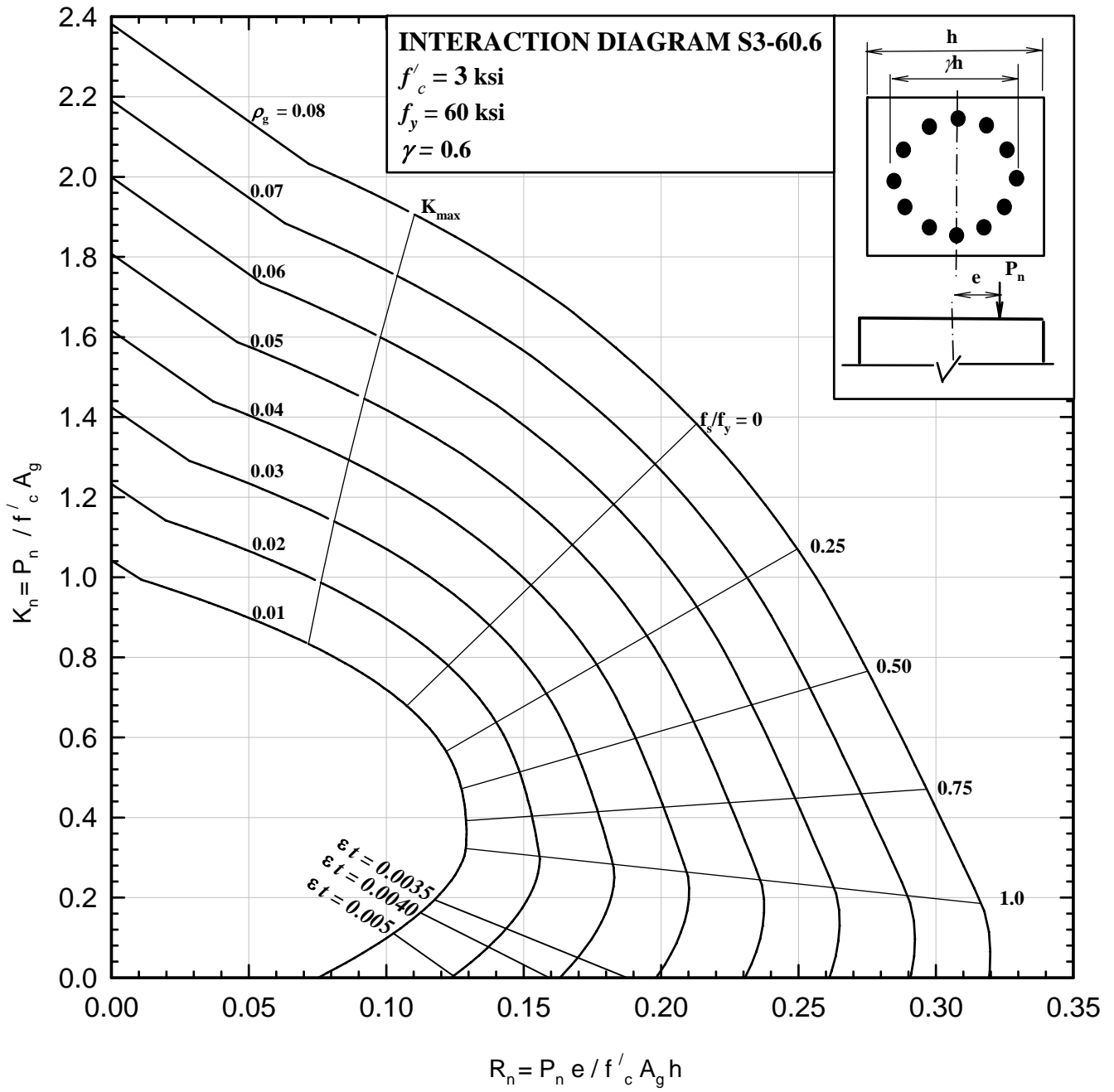

COLUMNS 3.19.2 - Nominal load-moment strength interaction diagram, S3-60.7

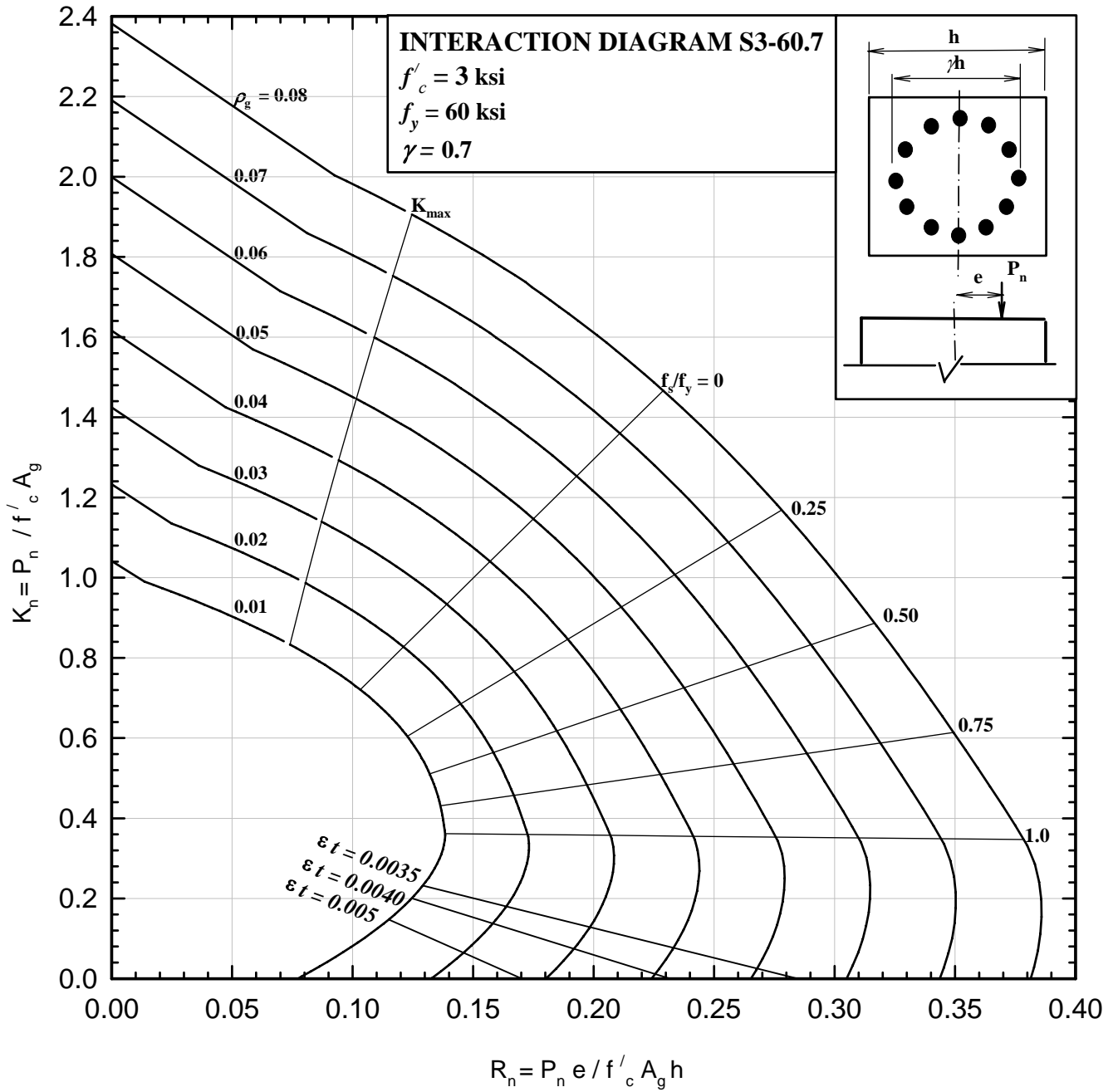

COLUMNS 3.19.3 - Nominal load-moment strength interaction diagram, S3-60.8

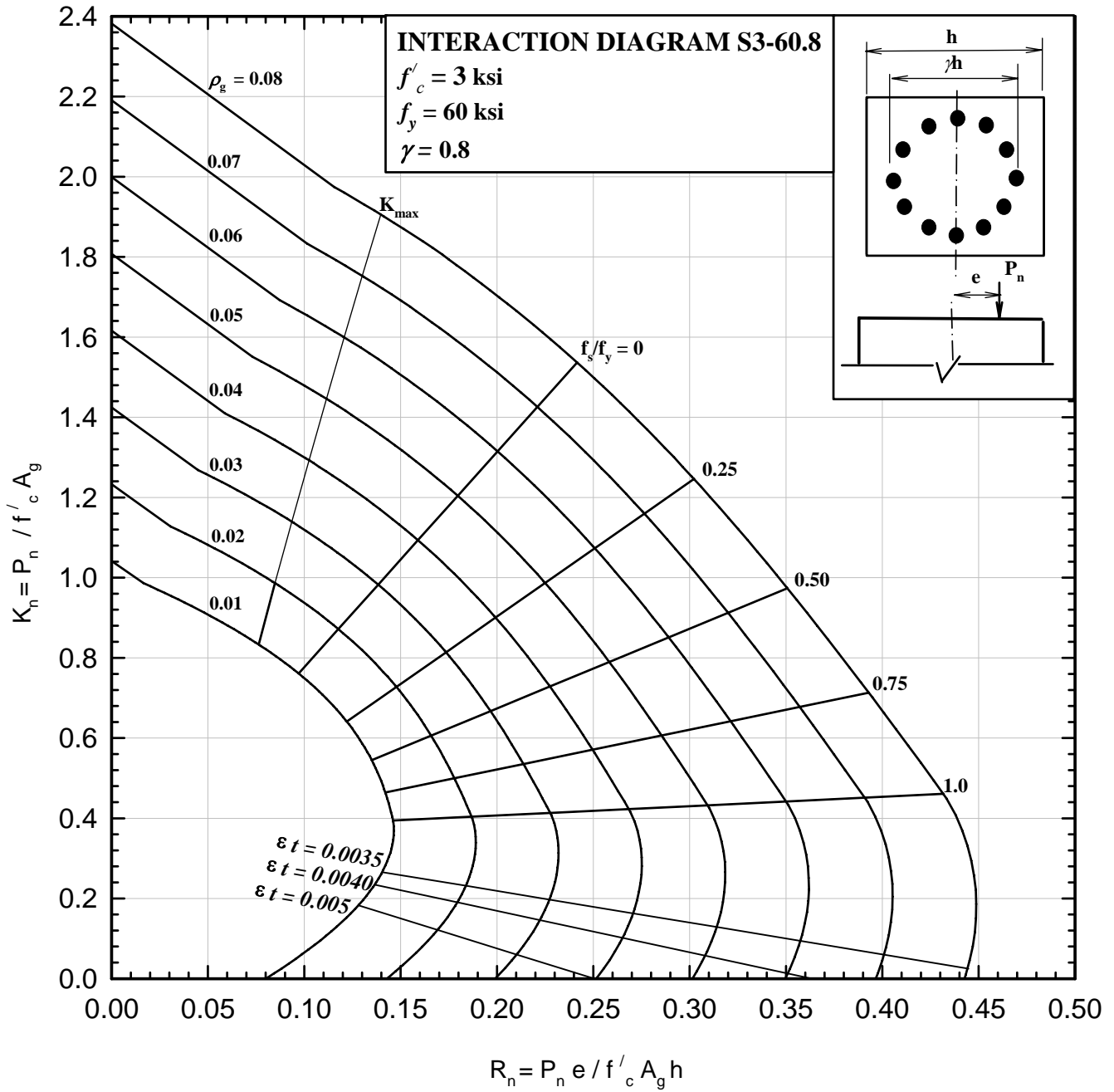

COLUMNS 3.19.4 - Nominal load-moment strength interaction diagram, S3-60.9

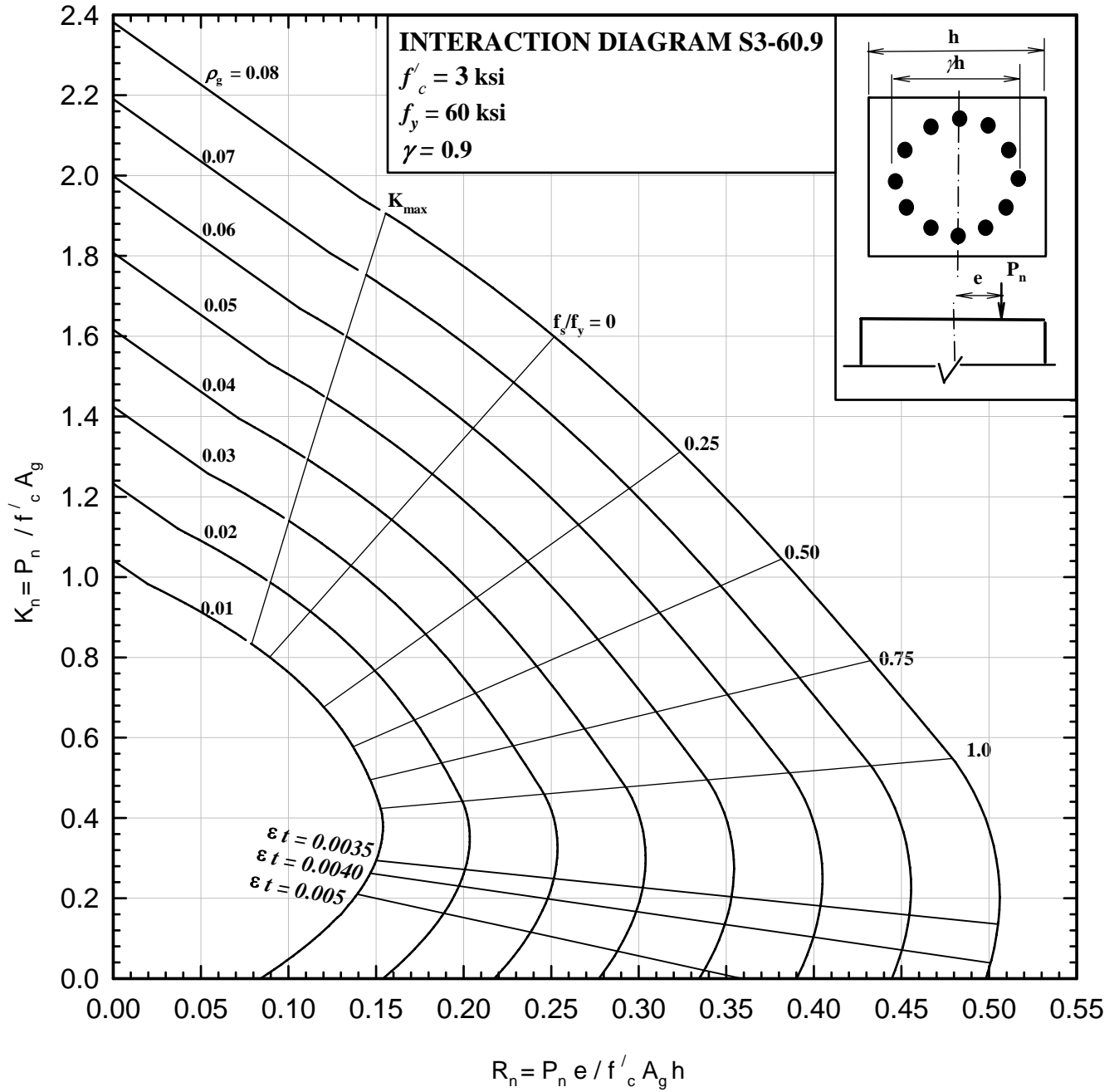

COLUMNS 3.20.1 - Nominal load-moment strength interaction diagram, S4-60.6

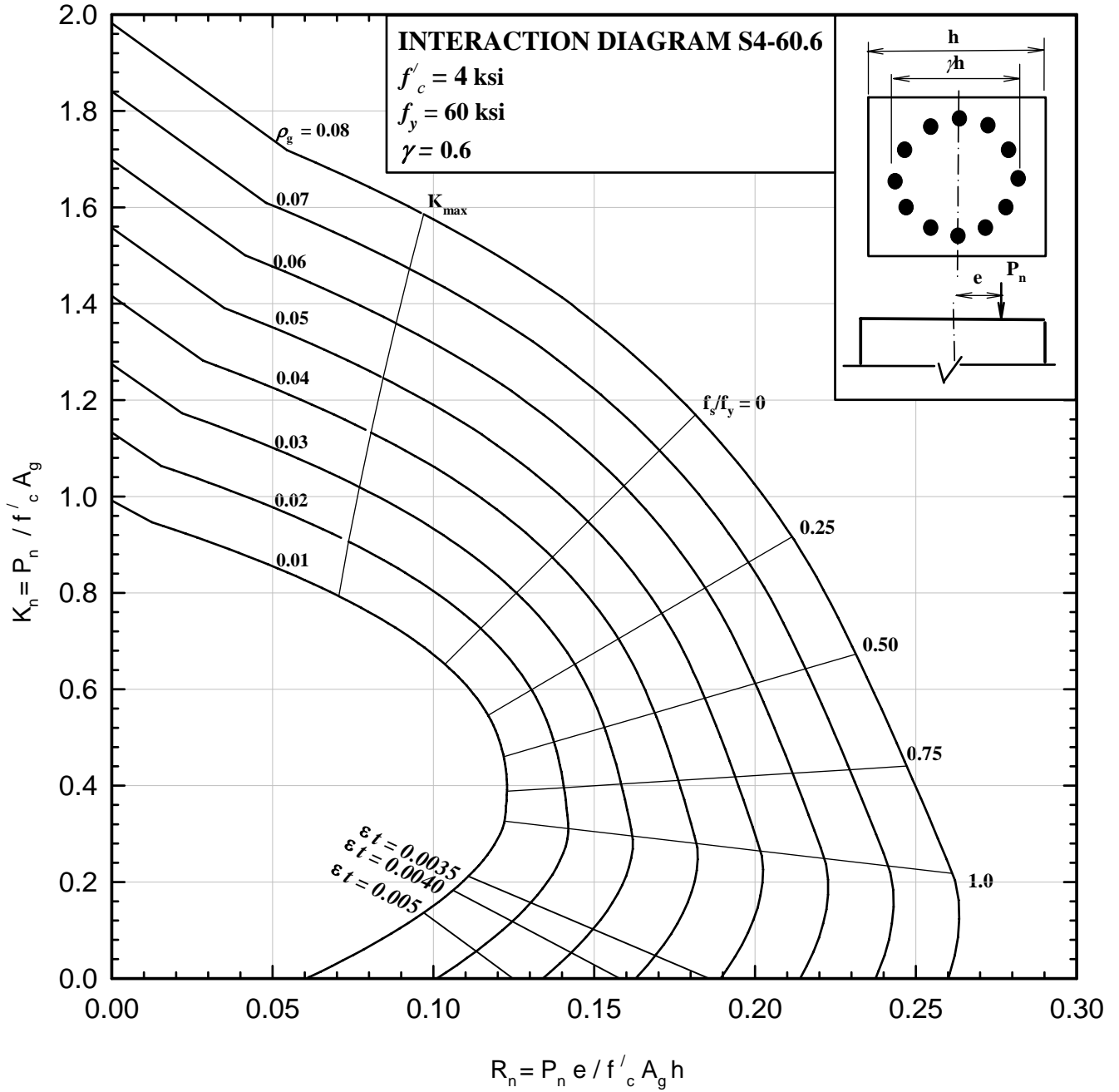

COLUMNS 3.20.2 - Nominal load-moment strength interaction diagram, S4-60.7

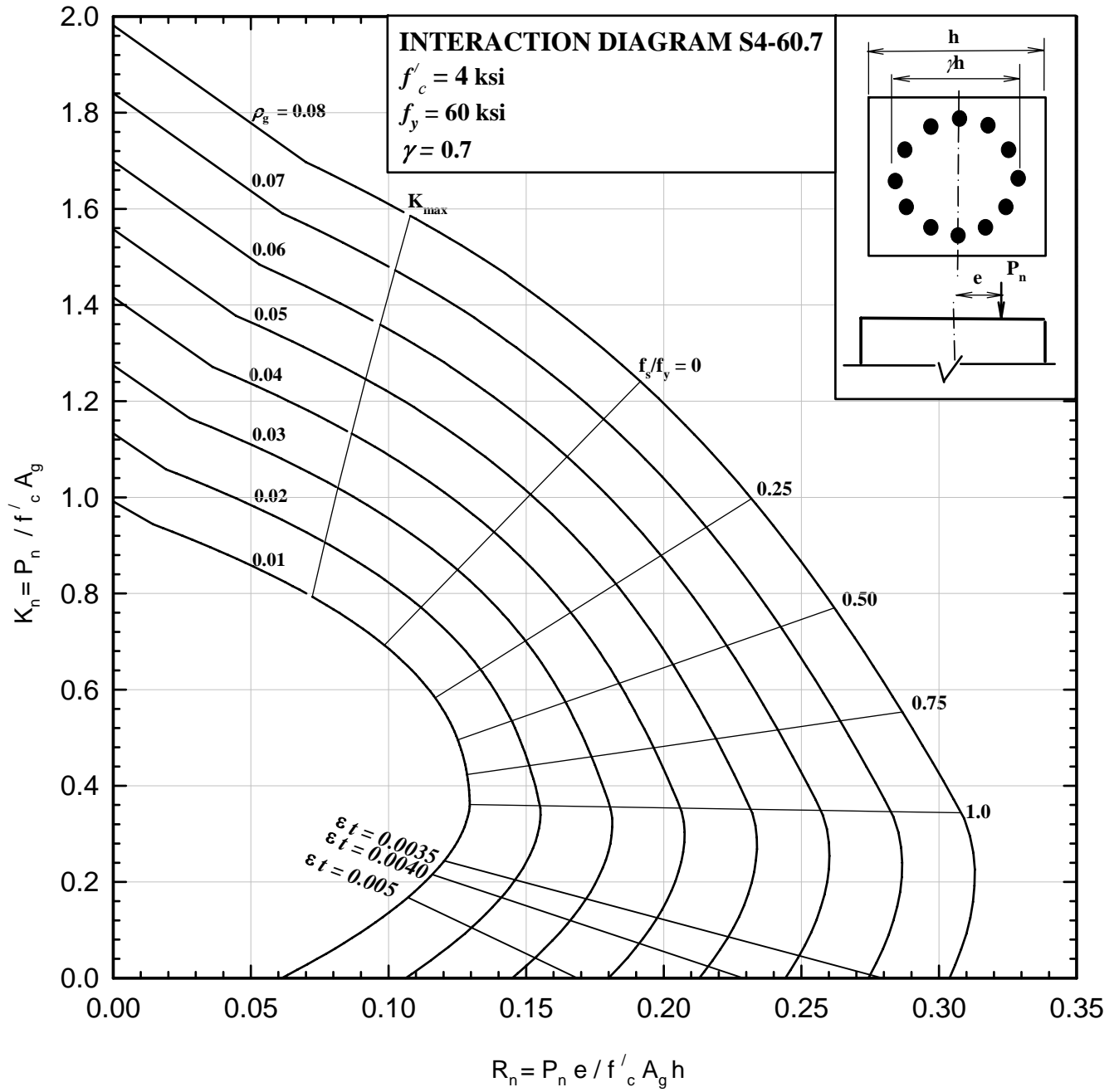

COLUMNS 3.20.3 - Nominal load-moment strength interaction diagram, S4-60.8

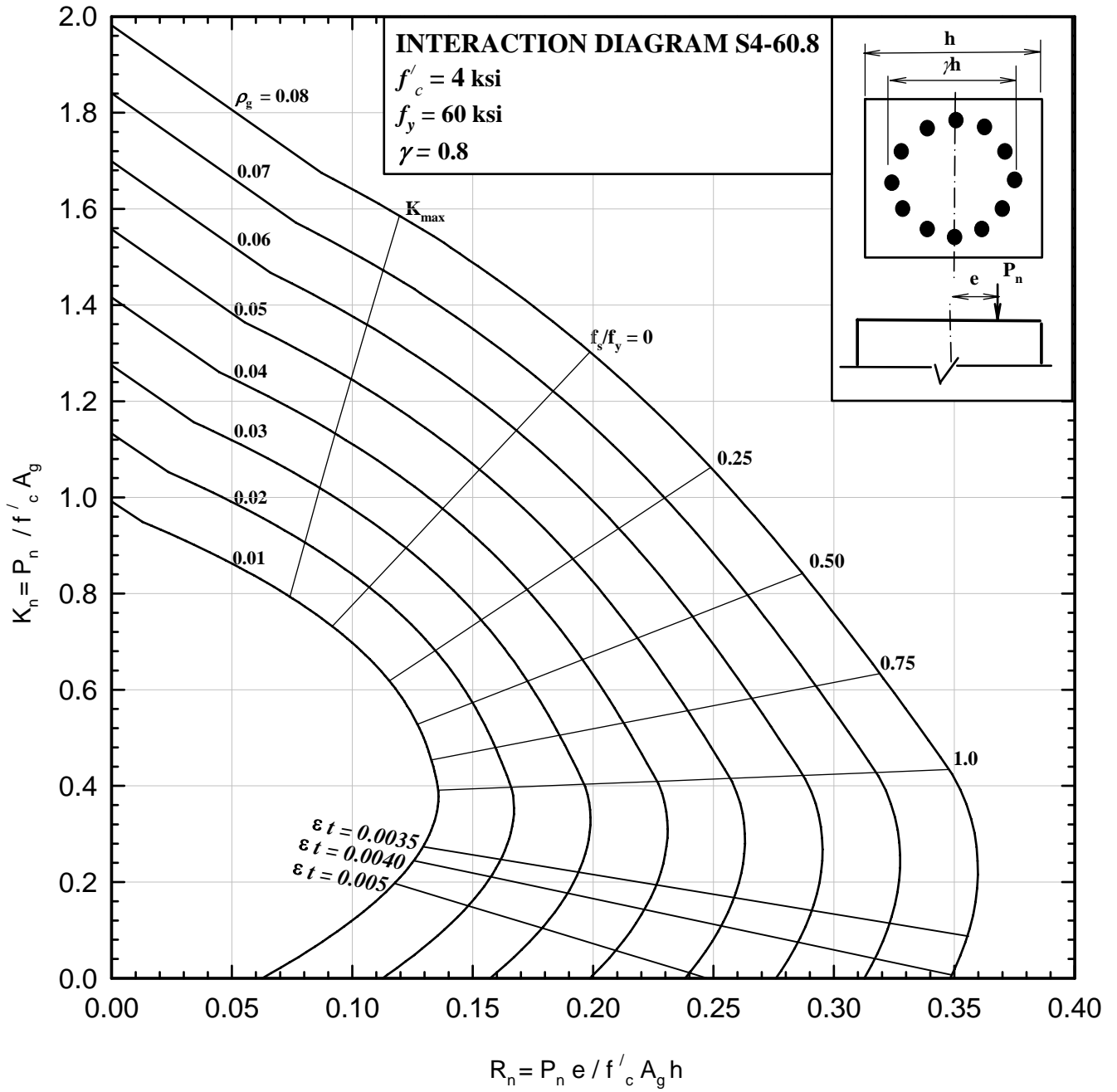

COLUMNS 3.20.4 - Nominal load-moment strength interaction diagram, S4-60.9

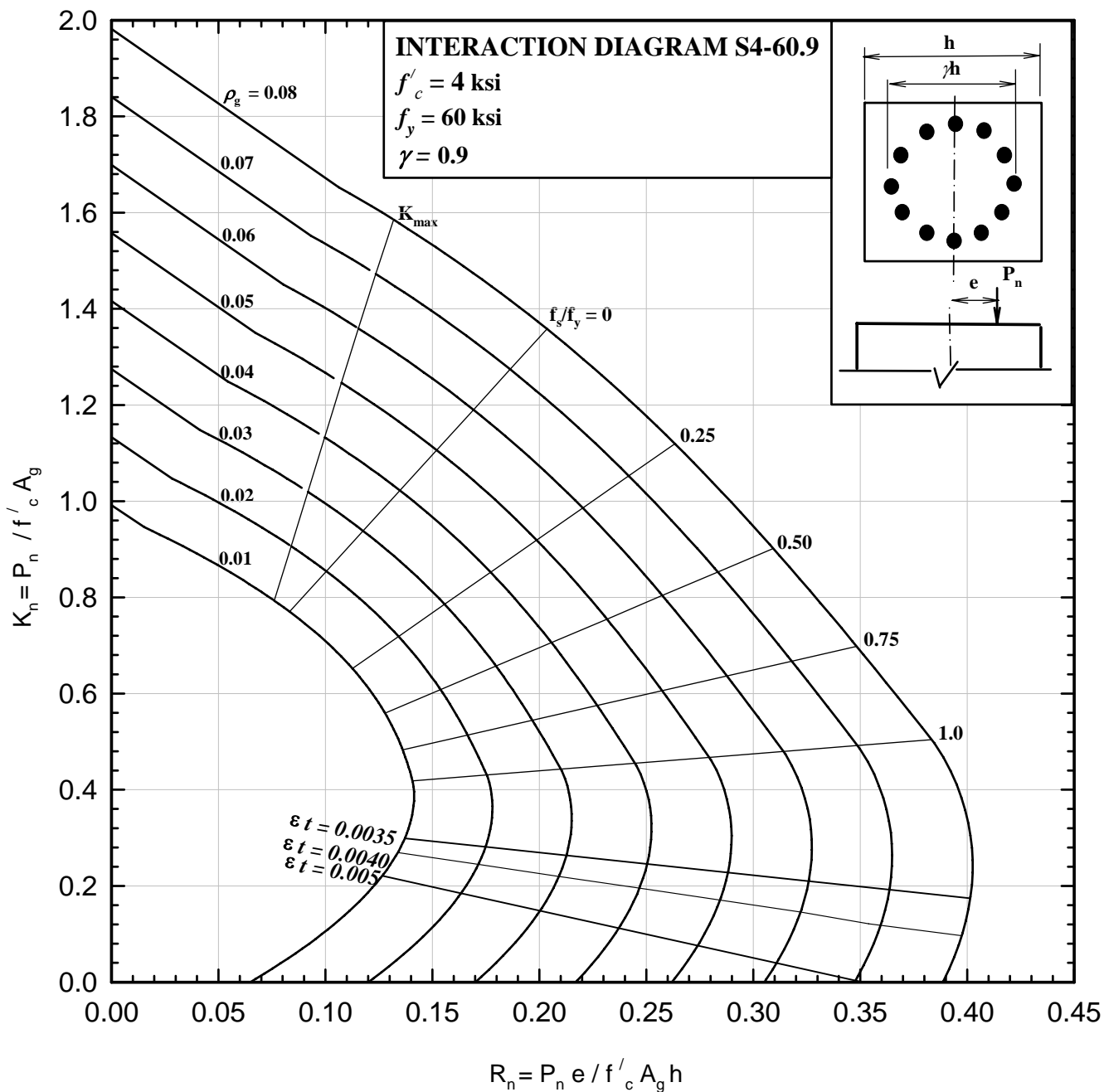

COLUMNS 3.21.1 - Nominal load-moment strength interaction diagram, S5-60.6

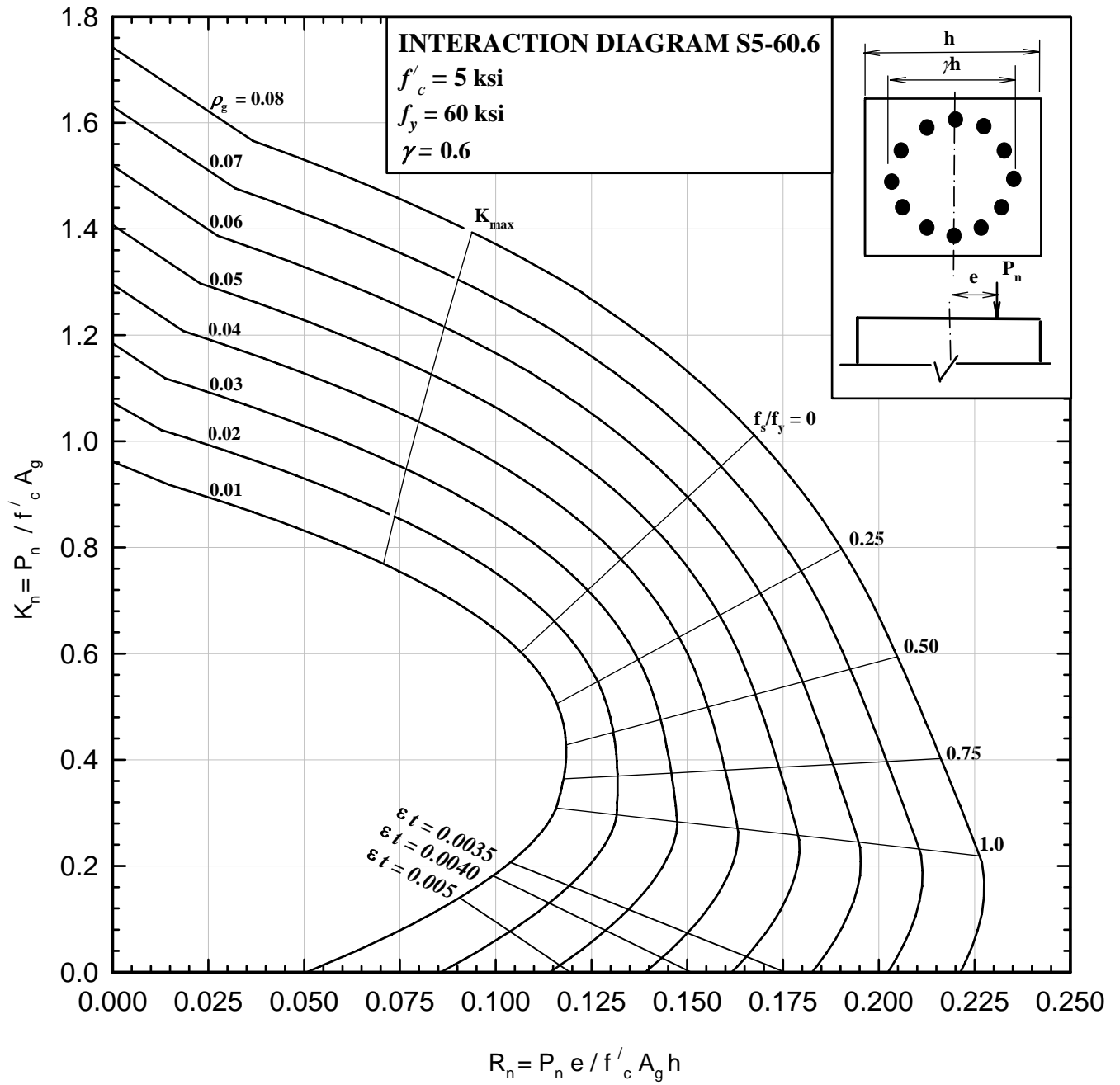

COLUMNS 3.21.2 - Nominal load-moment strength interaction diagram, S5-60.7

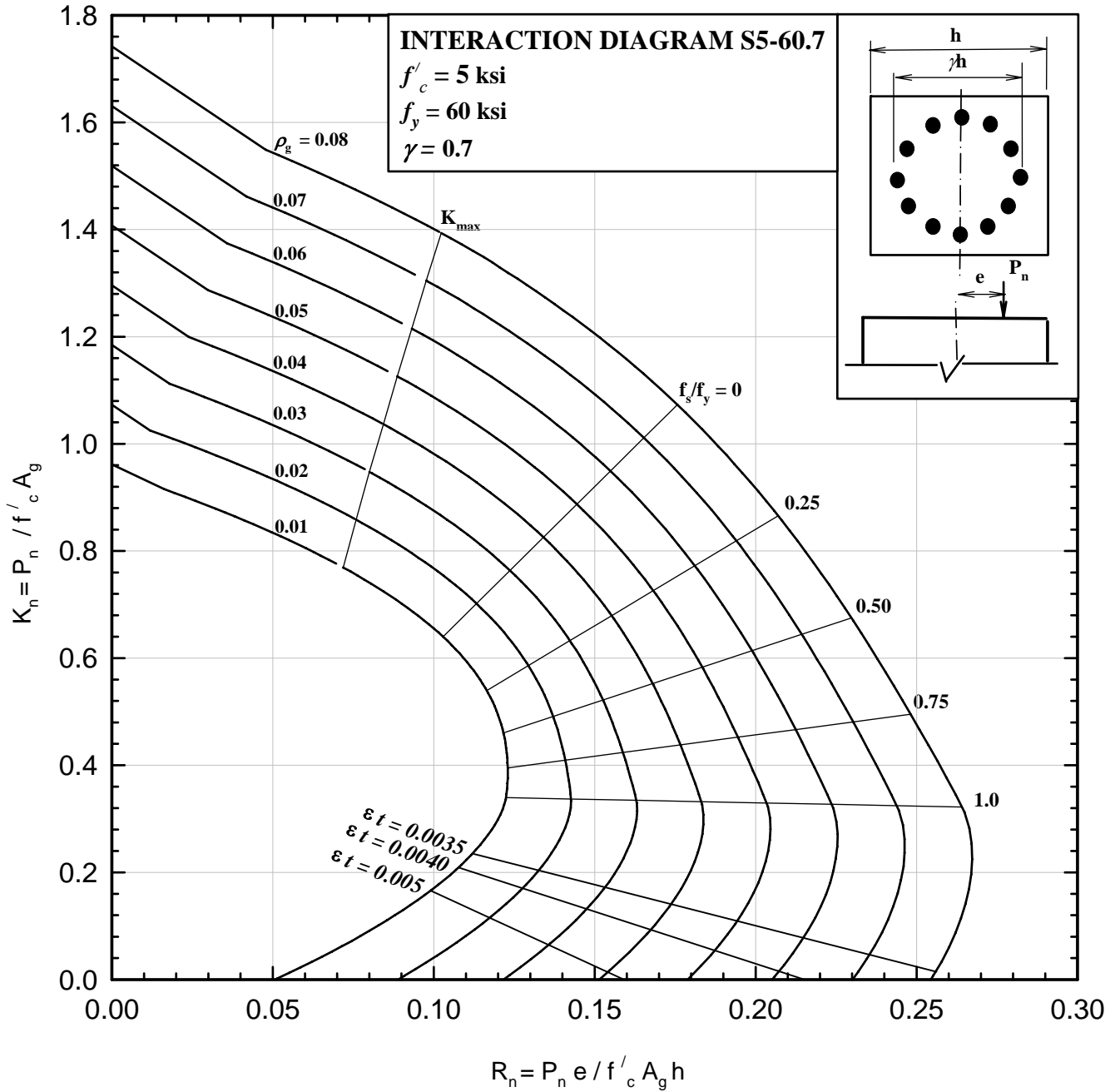

COLUMNS 3.21.3 - Nominal load-moment strength interaction diagram, S5-60.8

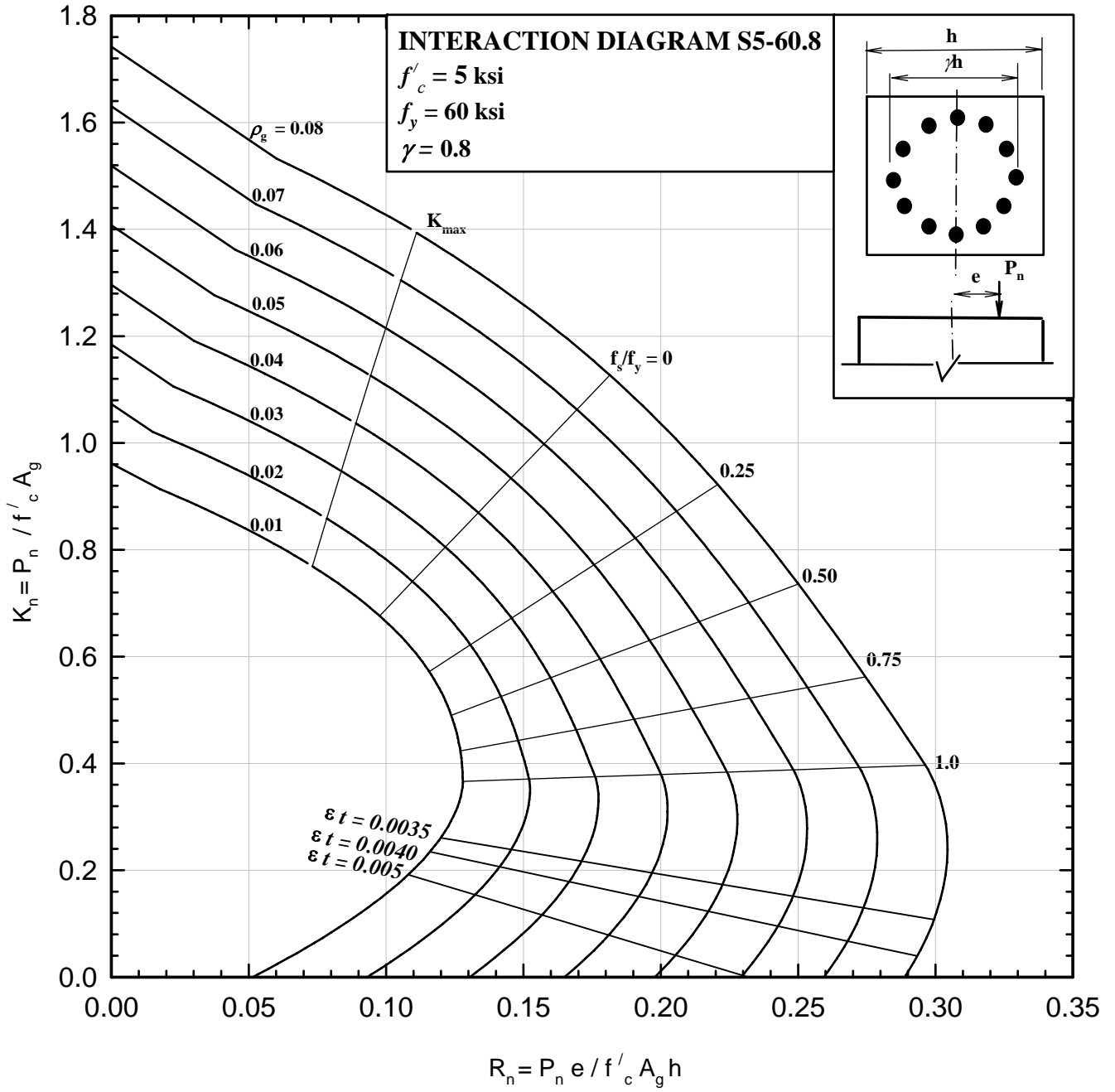

COLUMNS 3.21.4 - Nominal load-moment strength interaction diagram, S5-60.9

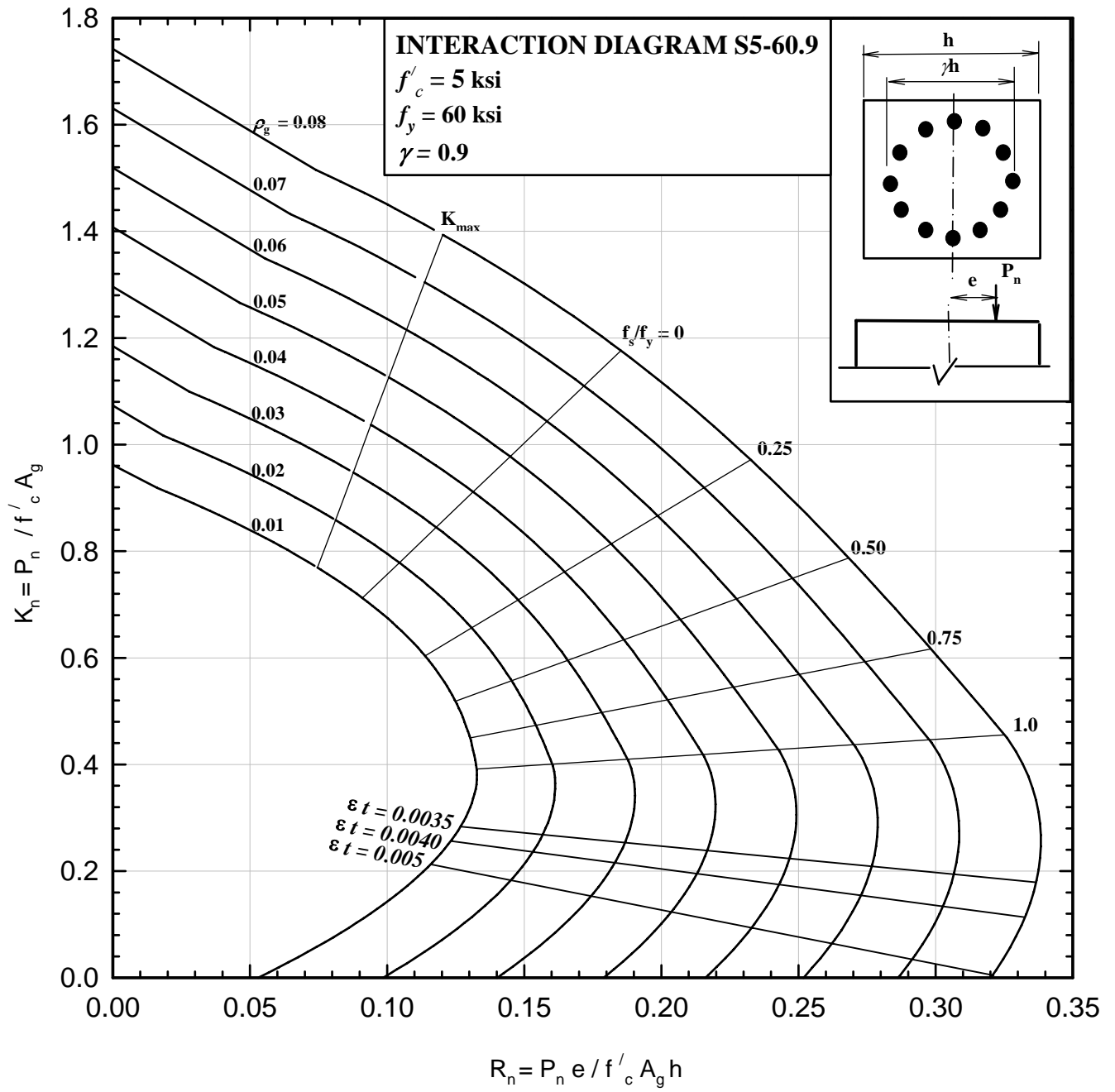

COLUMNS 3.22.1 - Nominal load-moment strength interaction diagram, S6-60.6

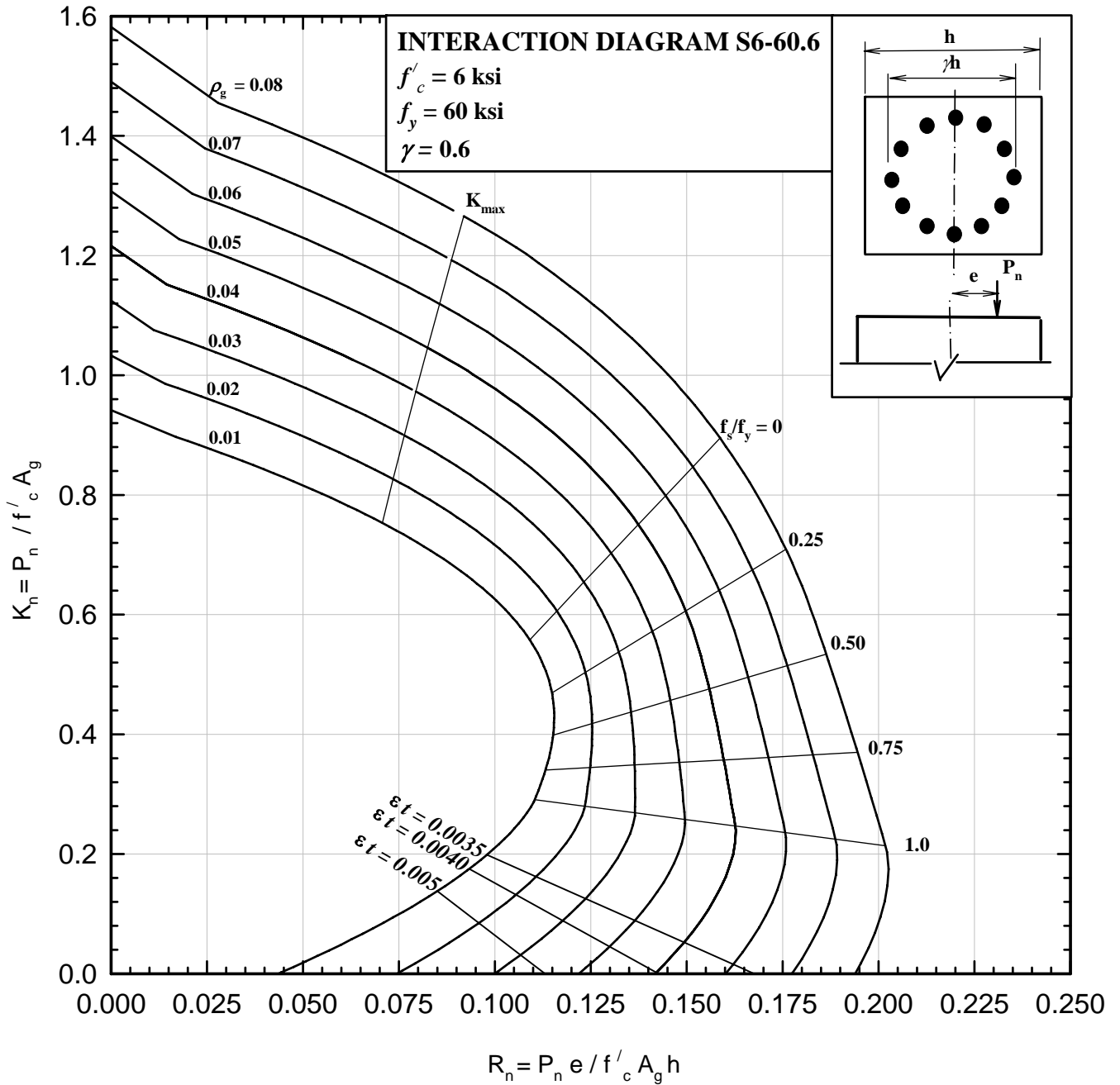

COLUMNS 3.22.2 - Nominal load-moment strength interaction diagram, S6-60.7

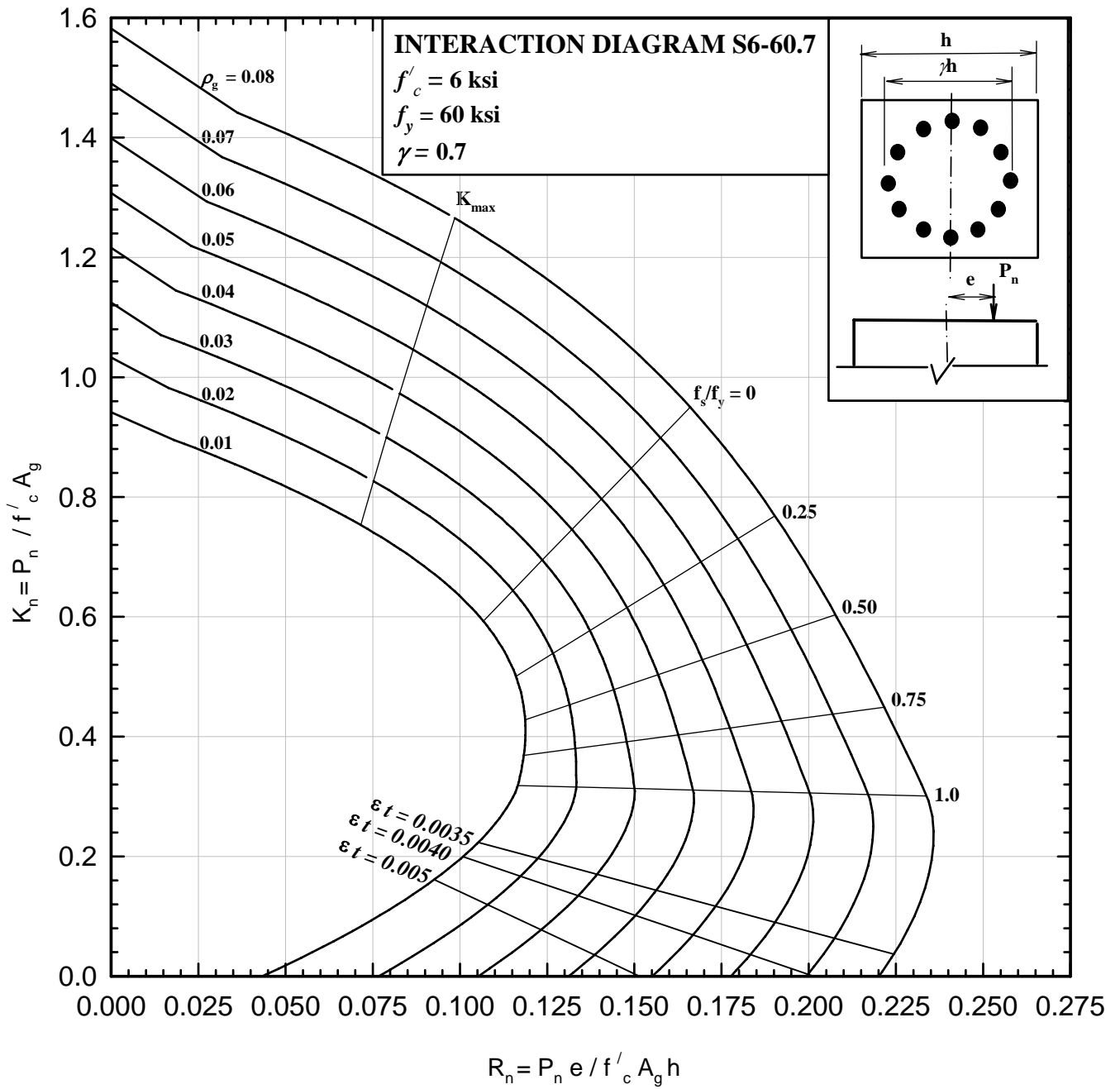

COLUMNS 3.22.3 - Nominal load-moment strength interaction diagram, S6-60.8

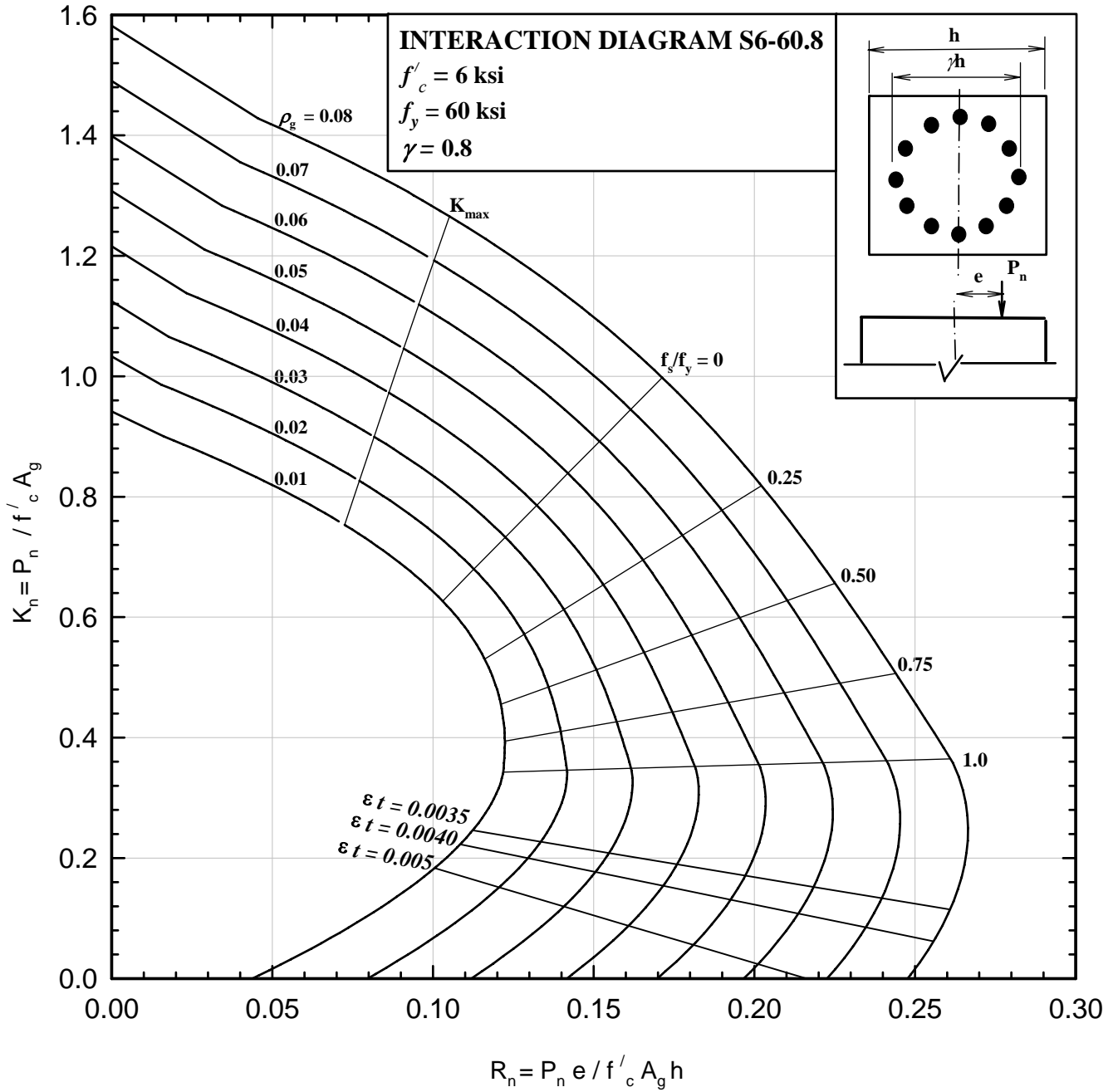

COLUMNS 3.22.4 - Nominal load-moment strength interaction diagram, S6-60.9

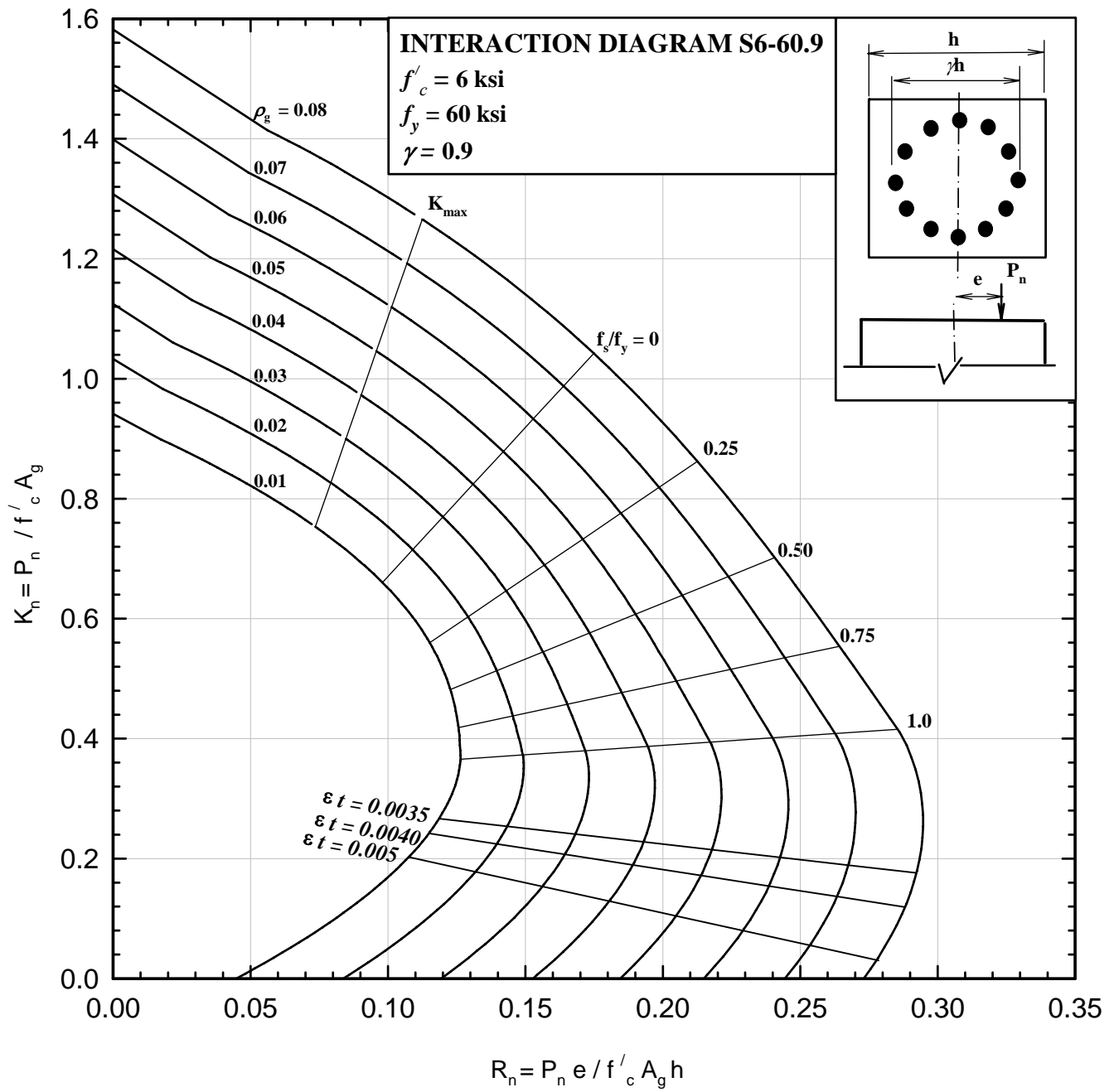

COLUMNS 3.23.1 - Nominal load-moment strength interaction diagram, S9-75.6

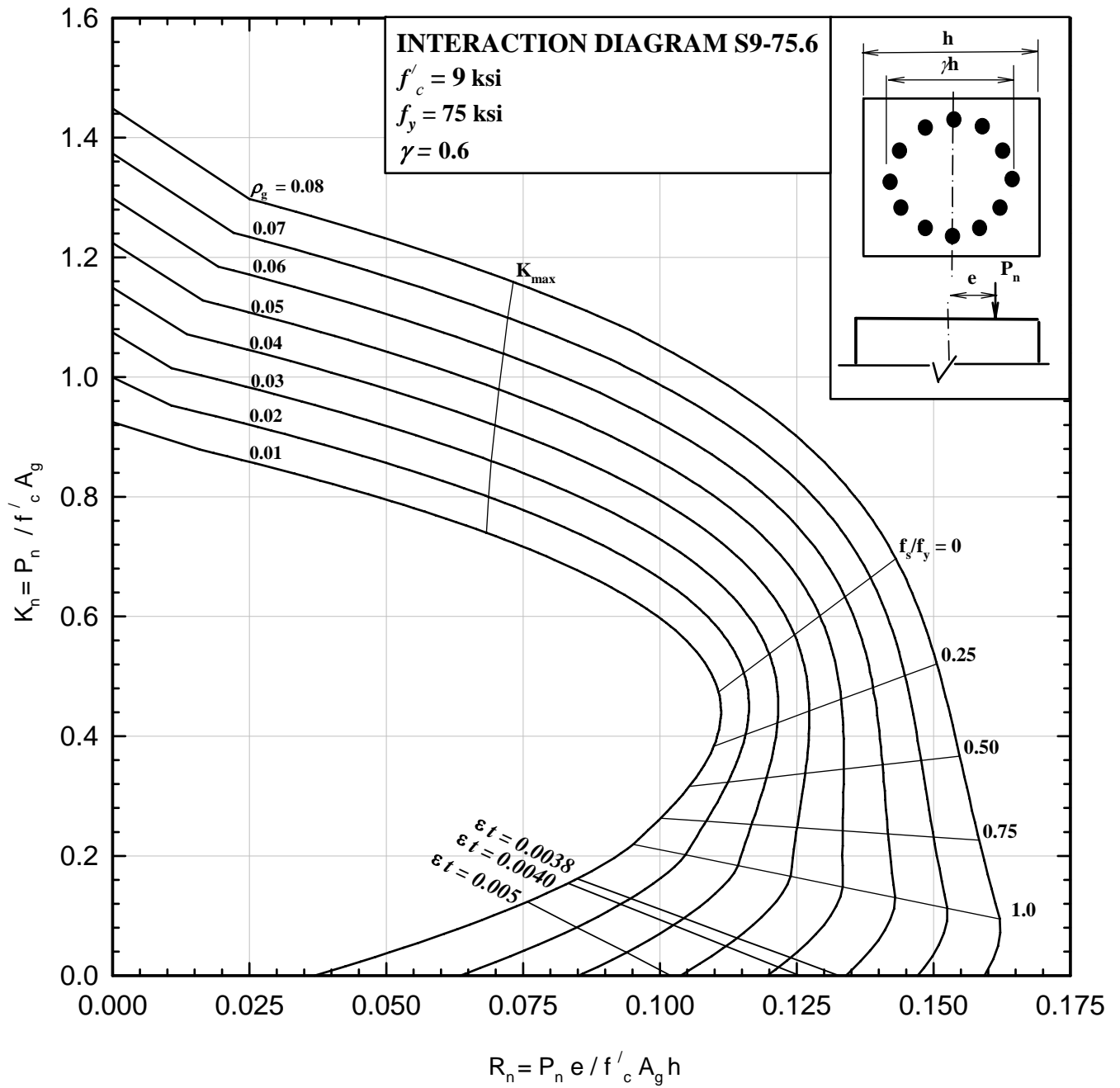

COLUMNS 3.23.2 - Nominal load-moment strength interaction diagram, S9-75.7

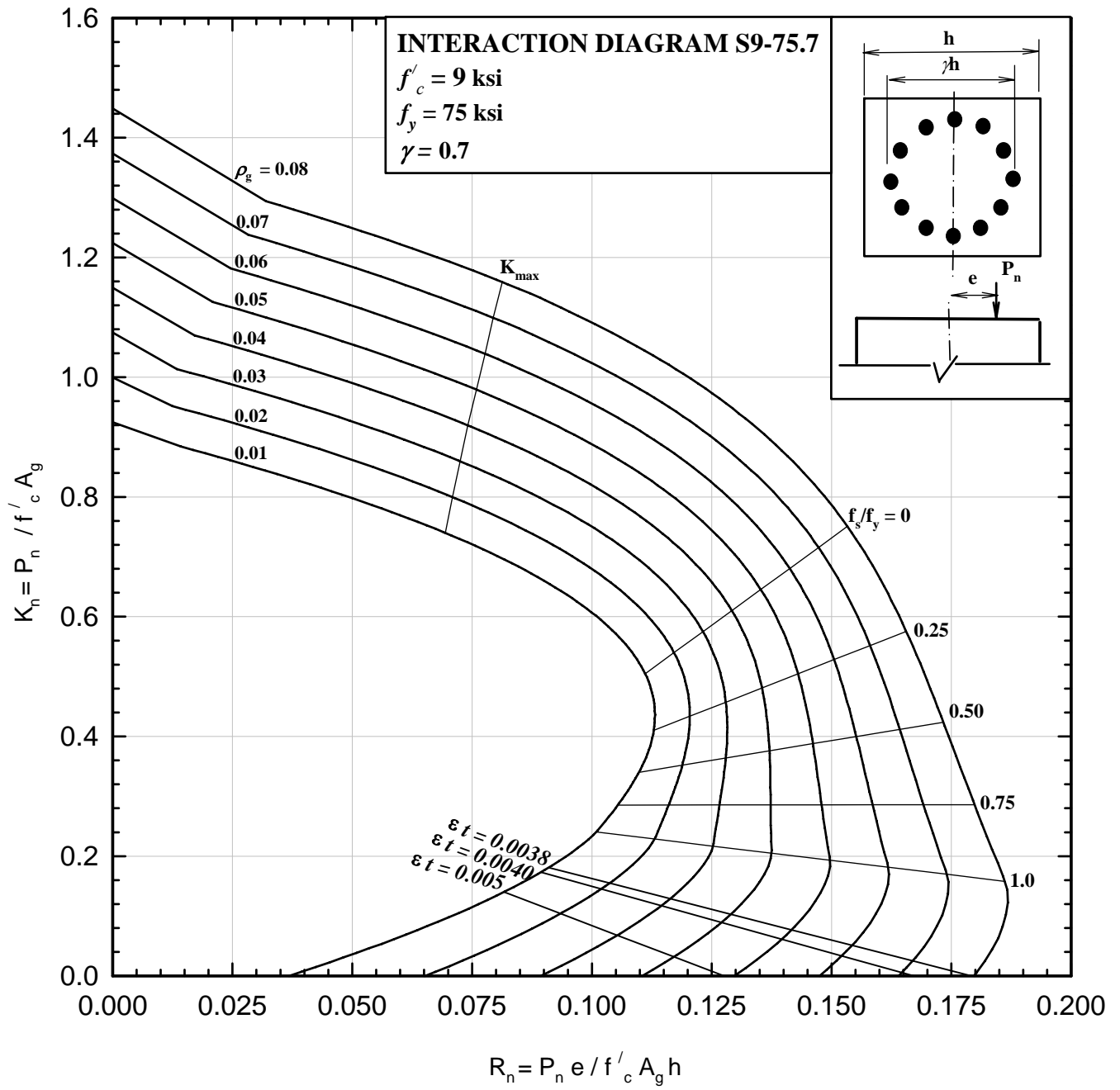

COLUMNS 3.23.3 - Nominal load-moment strength interaction diagram, S9-75.8

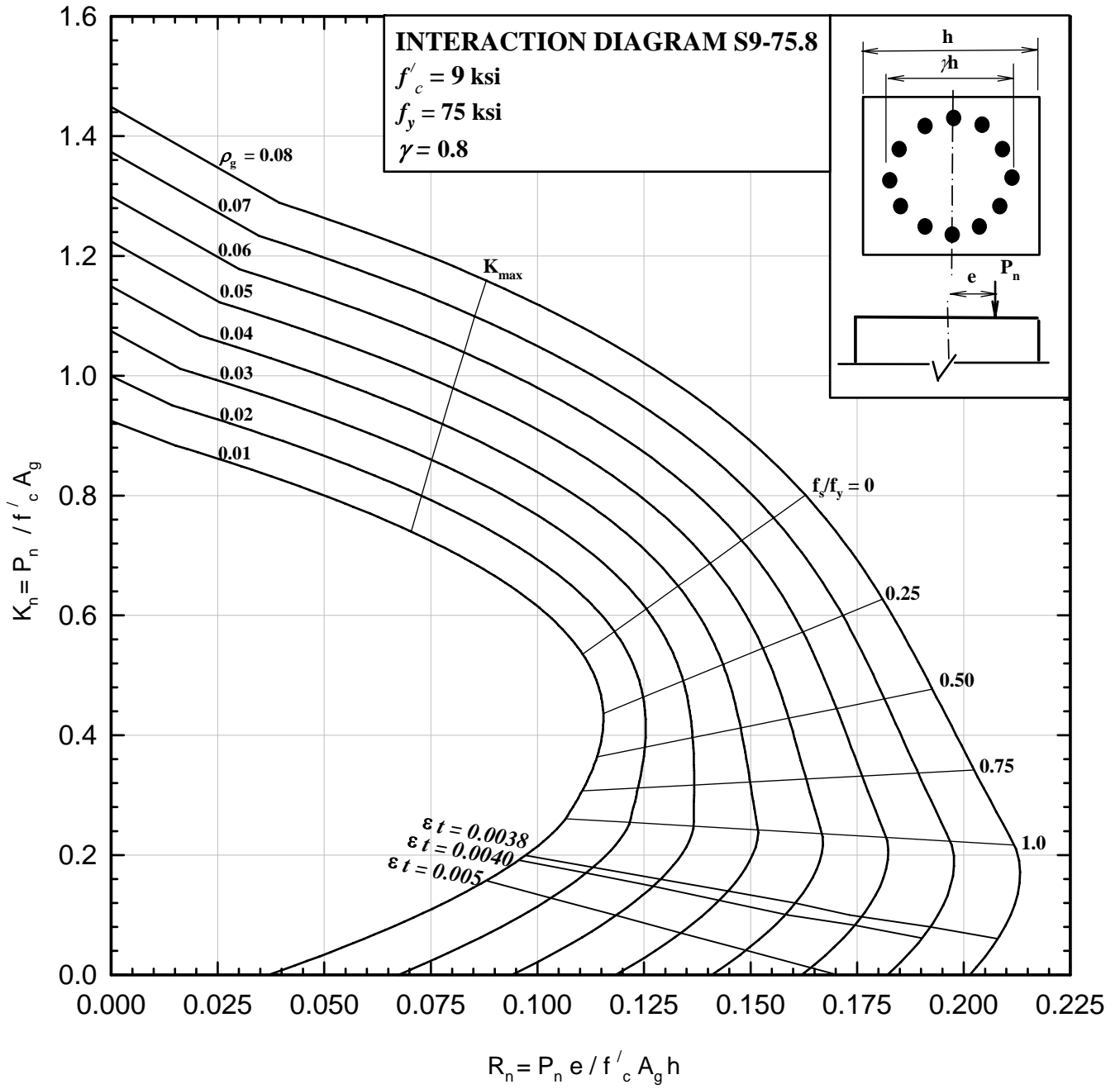

COLUMNS 3.23.4 - Nominal load-moment strength interaction diagram, S9-75.9

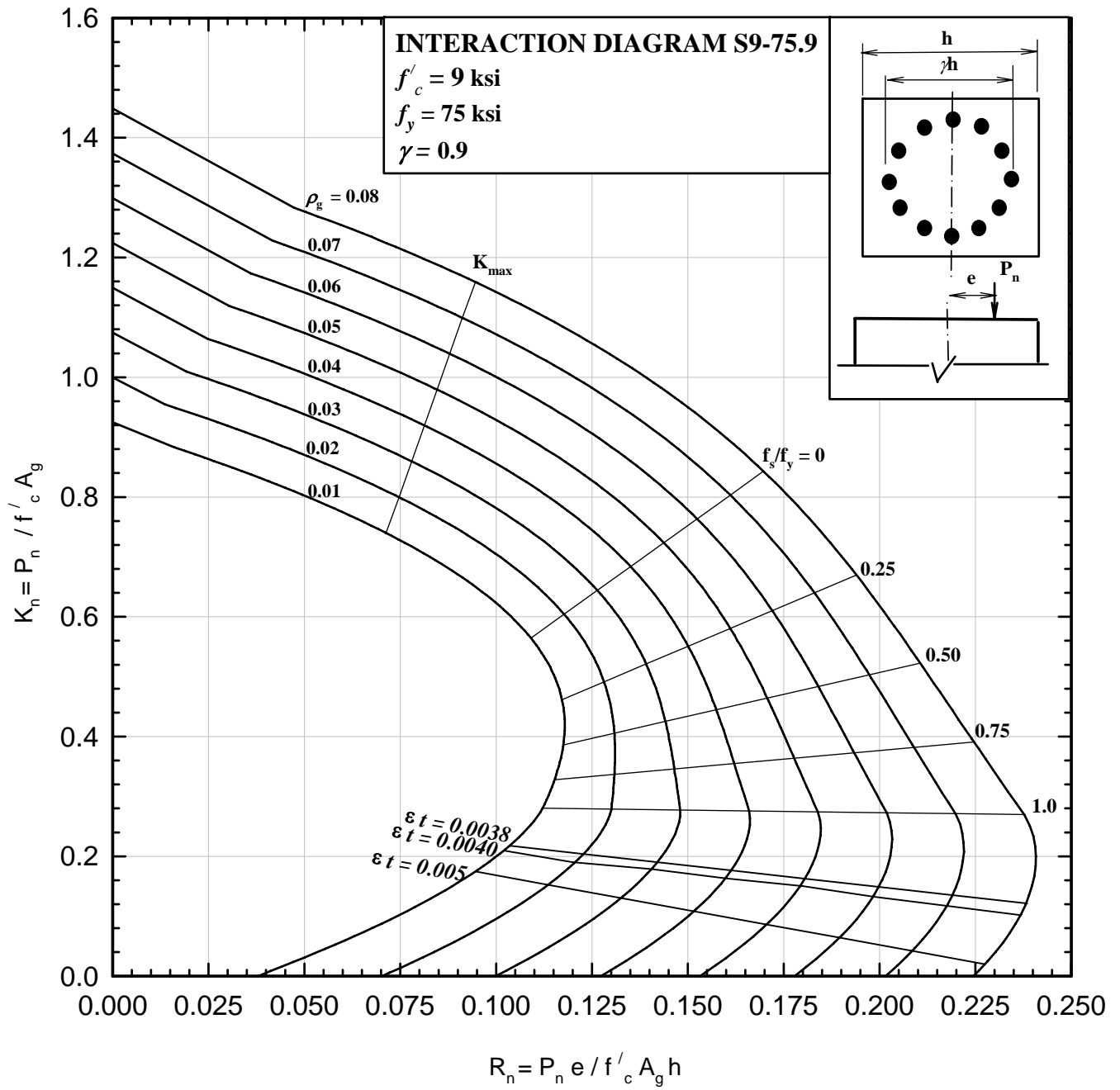

COLUMNS 3.24.1 - Nominal load-moment strength interaction diagram, S12-75.6

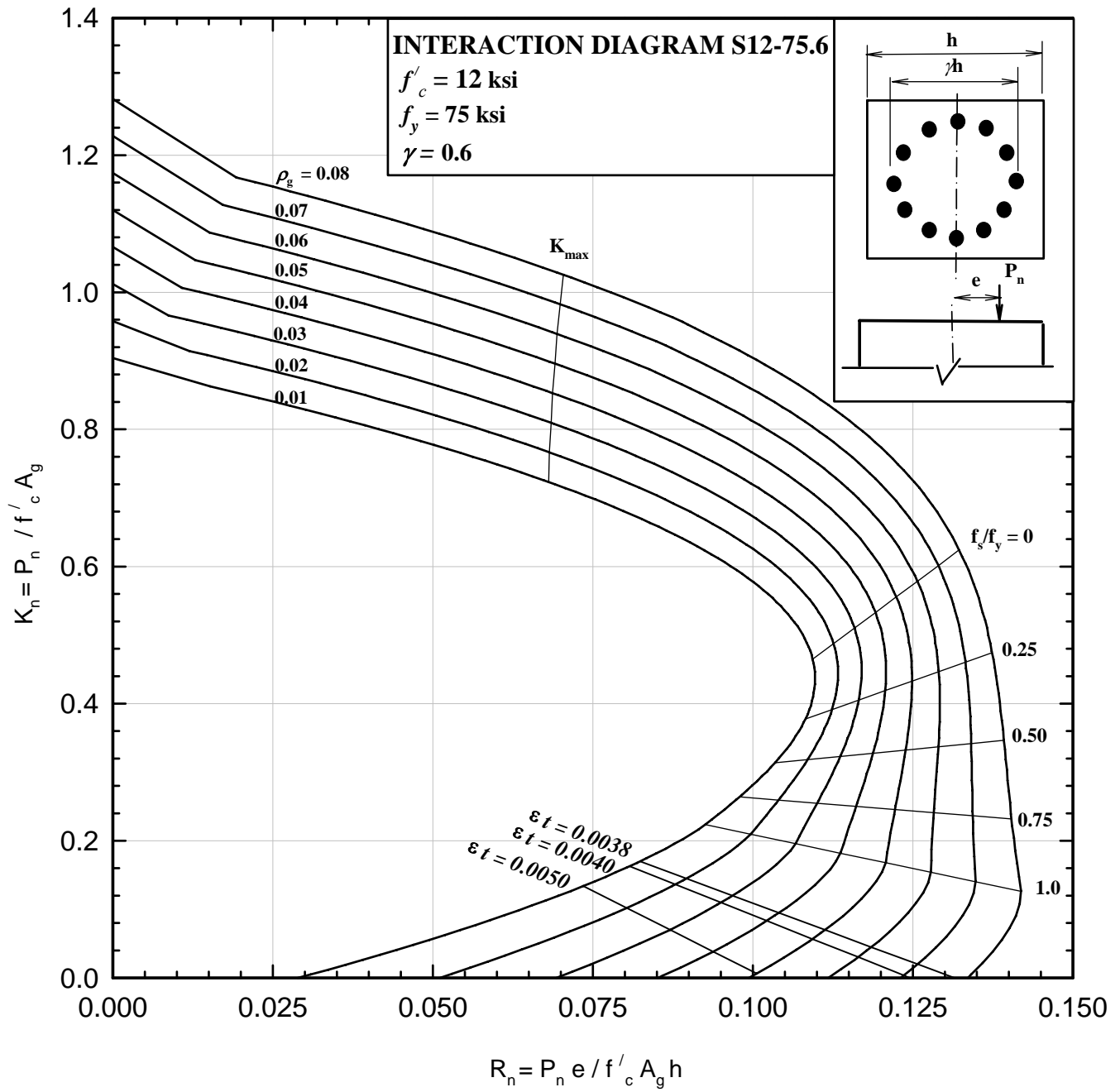

COLUMNS 3.24.2 - Nominal load-moment strength interaction diagram, S12-75.7

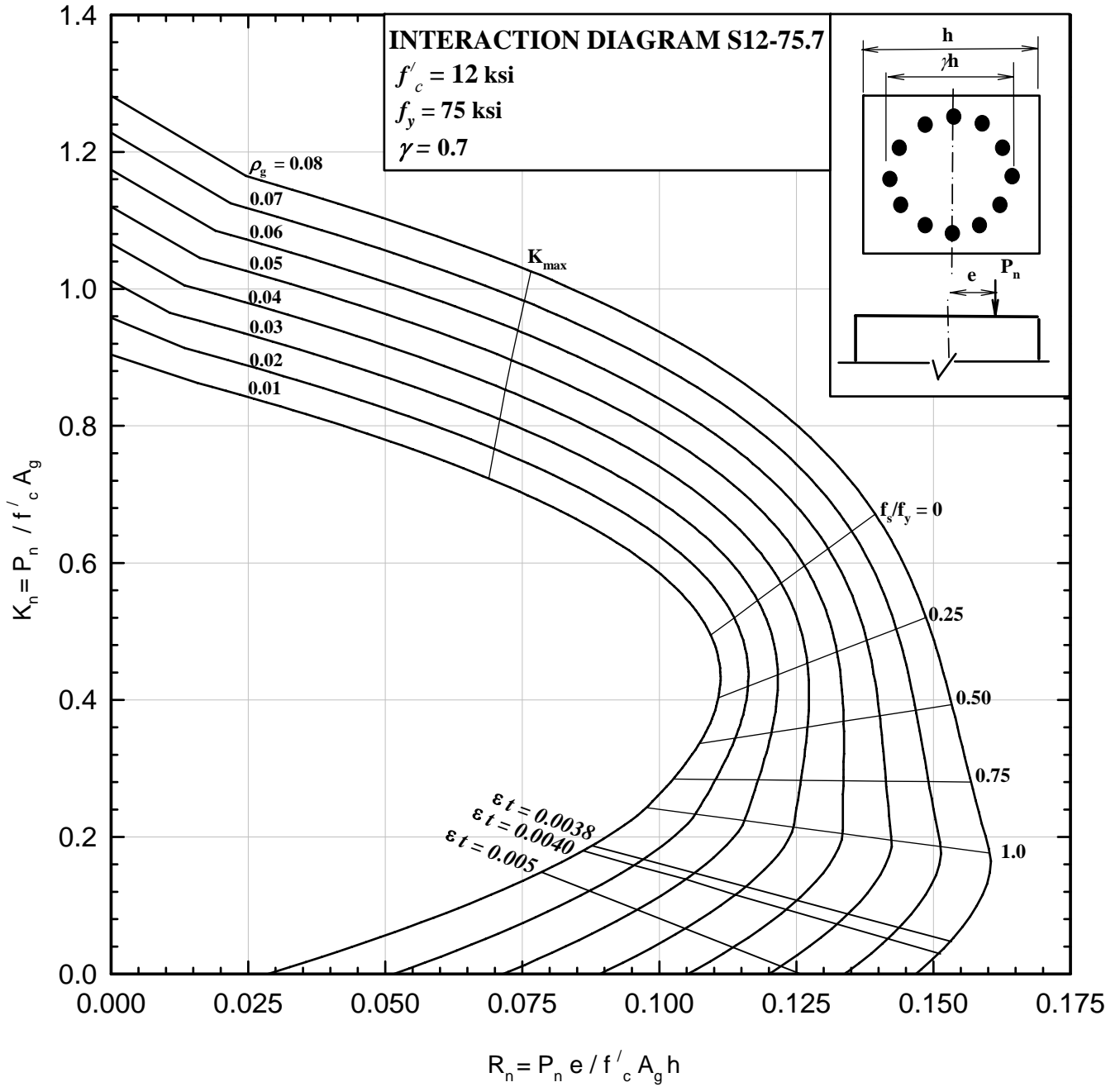

COLUMNS 3.24.3 - Nominal load-moment strength interaction diagram, S12-75.8

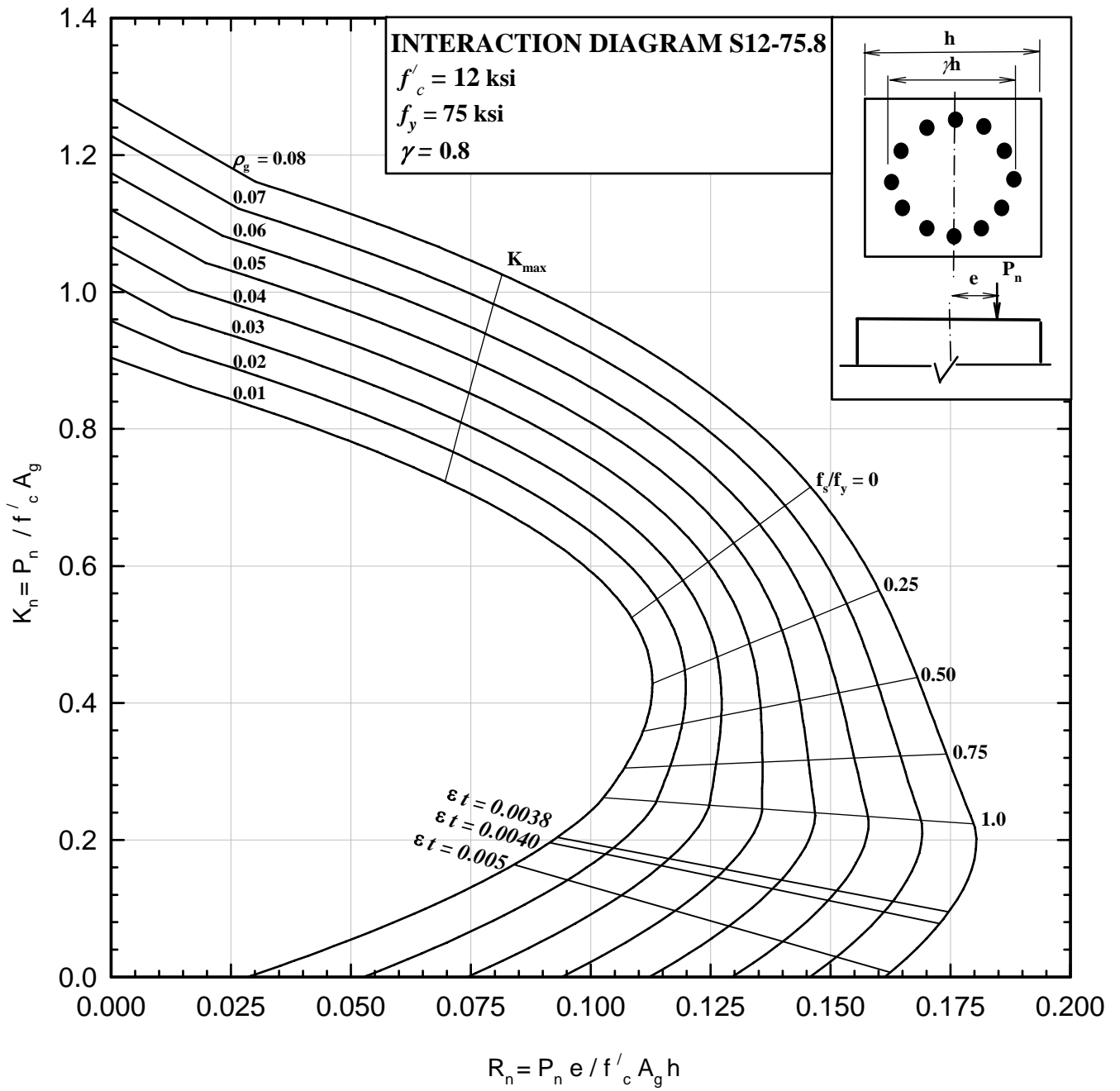

COLUMNS 3.24.4 - Nominal load-moment strength interaction diagram, S12-75.9

